

Critical Process Vessels



Superior
Performance
For Your
Demanding
Applications

Saint-Gobain High-Performance Vessels

Where Quality and Toughness Count, There's a Saint-Gobain High-Performance Tank

Saint-Gobain Performance Plastics tanks are tough. They're lightweight and corrosion-resistant. Their seamless design eliminates the major cause of leakage associated with lesser quality plastic tanks. Saint-Gobain Performance Plastics tanks won't wick or crack like fiberglass. And, our tanks are easier to maintain and much less expensive than stainless steel. Saint-Gobain Performance Plastics tanks are rotationally molded in a variety of high-quality virgin resin materials to match your specific application.

Our products are manufactured under a quality management system registered as complying with ISO 9001:2000, which has been independently certified by BVQI.

Reliability and Toughness Expanded

Saint-Gobain Performance Plastics also offers high-quality blowers, safety equipment, fittings and accessories. Like our tanks, they feature the quality, reliability and toughness you've come to expect from Saint-Gobain.

Service and Support—We're Here When You Need Us

Saint-Gobain Performance Plastics offers free technical assistance and a knowledgeable network of sales representatives committed to your complete satisfaction. We'll help you select the right Saint-Gobain Performance Plastics product for your specific requirements. We'll educate, inform and demonstrate the advantages our tanks offer over other competitive containers. And with our exclusive warranty, we'll supply you with a reliable system that will last and last.

Saint-Gobain Performance Plastics Rotational-Molded Tanks Offer Distinct Advantages

Service Depends on Contents, Location, Temperature and Other Conditions

- Lower cost than stainless steel or fiberglass
- Virtually maintenance-free
- Seamless construction for easy cleaning
- Available in a wide variety of resins and leakproof service
- Most tanks have a visible liquid level
- Controlled wall thickness without corner thinning
- Lightweight; less than one-half the weight of steel

Special Notes

- Tanks with Fiberglass-Reinforced Polyester (FRP) Casings offer service to higher temperatures and with higher specific gravity contents.
- Operating conditions and chemical usage can decrease maximum service temperatures.
- Continuous service temperatures in ranges above ambient can affect tanks in at least two ways: 1) the useful life of the tank may be shortened; and 2) the ability of the container to maintain its shape may decrease, perhaps resulting in distortion.

Plastic tanks which are subject to chemical, physical and/or thermal exposure should be inspected on a routine basis for any signs of leaking, cracking, discoloration, bulging or other deviations from the "as new" condition. The frequency of inspection will be highly dependent upon actual use conditions, as well as the age of the tank. Specific guidelines must be determined by the user dependent upon actual use conditions. Saint-Gobain Performance Plastics cannot provide

specific guidelines due to the wide variety of applications and their effects on plastic tanks. Please consult this catalog or contact Saint-Gobain Performance Plastics for more information.

Quality Design Assures Long, Reliable Life

Our tanks feature generous, rounded corners that have less molded-in stress. This construction makes them less likely to crack and easier to clean.

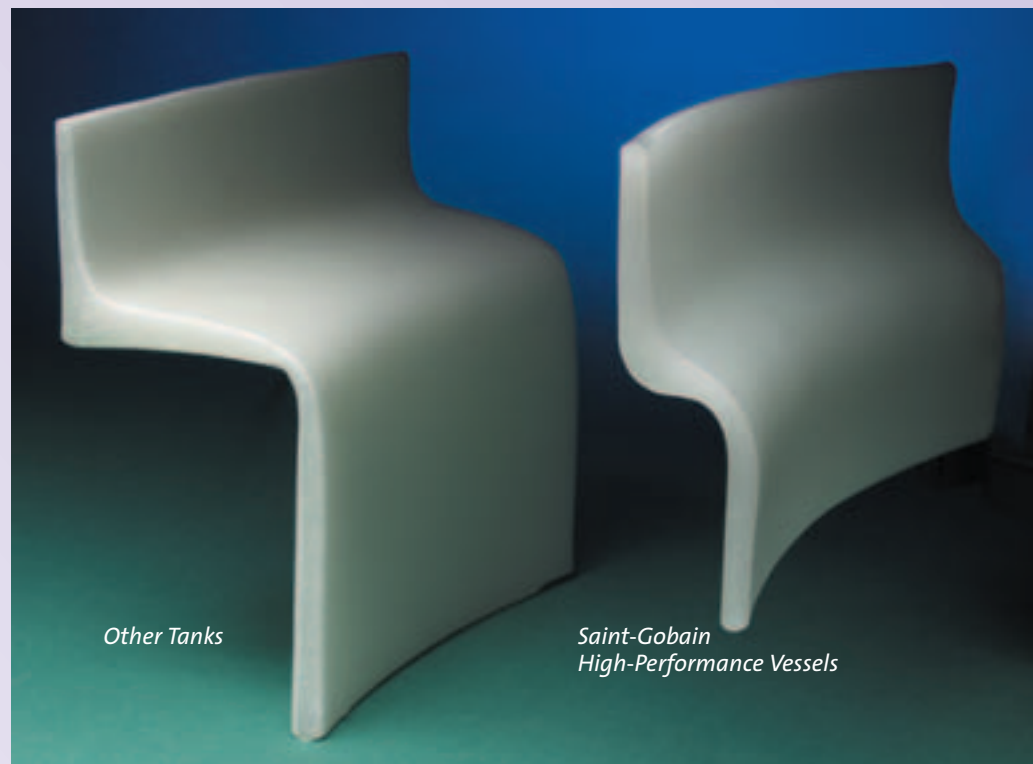

Other Tanks

Saint-Gobain High-Performance Vessels

Table of Contents

By Catalog Number Series By Product and Subject

Cat. No.	Page	Cat. No.	Page	Cat. No.	Page
2624	18	16520	5	72721	40-43
2650	18	18100	4	72730	42-43
2653	21	18200	4	72731	40-43
2654	21	18300	4	72821	40
2656	25	19000	4	72830	42-43
2658	25	19009	9	72831	40-43
2660	23	19010	9	76000	13, 35
2661	23	20010	9	86200	34
2662	24	25100	33	86301	34
2663	24	25300	33	86302	34
2665	24	48080	13	86303	35
2666	24	48090	13	86304	34
2669	24	51105	30	86320	34
2670	23	51109	30	86400	34
2671	23	51305	30	86501	34
2672	23	51309	30	86626	34
2673	22	53009	32	86650	34
2674	22	53109	32	86651	34
2677	26	53309	32	86780	35
2678	26	54100	4	86781	35
2680	26	54102	4	86890	35
2681	26	54104	11	86891	35
2685	24	56104	8	86900	34
2690	19	59000	35	87001	13
2691	19	59040	33	87005	12
2692	23	63100	10	87006	12
2695	22	63600	10	87500	11
2696	22	71300	43	88001	13
2697	22	71309	42, 34	89005	12
2710	20	71320	40, 43	93400	12
2711	20	71330	40, 43	93420	13
11100	4	71400	43	93840	12
11102	4	71409	42	93841	12
11150	8	71420	40, 43	93857	12
11200	4	71430	40, 43	93858	12
11250	8	71500	43	93859	12
11300	4	71509	42	95840	12
11500	4	71520	40, 43	95857	12
12000	7	71530	40, 43	96000	13
12300	7	716421	13	96423	12
14100	7	716422	13	97001	13
14150	6	72509	42	97003	13
14200	7	72510	44	97006	13
14250	6	72511	44	97103	13
14300	7	72520	41-43	97424	13
14350	6	72521	40-43	98001	13
14500	7	72530	41-43	98003	13
15000	6-7	72531	40-43	98103	13
16120	5	72609	42		
16220	5	72620	41-43		
16320	5	72631	40-43		

Introduction and Information

How to Select Your High-Performance Tank 2

Technical Information37

Food Grade Resins, Plastic Products for Biotechnology, Dimensions and Wall Thickness, Physical Service Capabilities, Environmental Stress-Cracking, Tensile Stresses, Common Stress-Cracking Agents, Susceptibility to Stress-Cracking, Physical Service Capabilities, Ultraviolet (UV) Stabilization

Chemical Storage38

Storage of Sodium Hypochlorite, Using Tanks with Common Chemicals

Chemical Resistance Charts39-44

Warranty and How to Order45

Open-Top Tanks

General Guide to Open-Top Tanks 3

Flat-Bottom Cylindrical Tanks 4

Conical-Bottom Tanks 5

Rectangular Tanks 6-7

Tank Flange Styles, Tanks With Flat Wide Flanges, Flat-Flange Rectangular Tanks

Cylindrical Tanks 8

Tapered General Purpose Containers, Closed-Dome Tanks

Cylindrical Tank Stands 9

Floor Stands, Elevated Stands for Flat-Bottom and Conical-Bottom Tanks, Options

Open-Top Tank Mixers 10

LIGHTNIN Mixer Features, Options

Open-Top Tank Fittings/Accessories 11-13

Floating Covers, Installed Hinges for Cylindrical Tank Covers, Installed and Loose Fittings, Bulkhead Fittings

Guidelines for Installation 14-15

Putting It All Together 16

Sanitary Vessels

Sanitary Tanks 17

Closed-Dome Bio Tanks 18

Closed-Dome Bio Tank Accessories

Sanitary Conical Process Vessels 19

Processing Tank Systems, Conical-Bottom Processing Tanks: Polypropylene and Polypropylene Fluoride

Sanitary Conical Tank Stands 20

Conical-Bottom Portable Tank Stands, Industrial-Style Stand Option

Sanitary Tank Mixers 21

BioTech Mixing Systems, BioTech Mixer Overhead Drives, Lower Assemblies/Shafts and Impellers

Sanitary Drain Options 22

Conical Drain Valve, Diaphragm Valve, Ball Valve

Sanitary Fittings and Accessories 23-26

Installed Sanitary Ferrules, Sanitary Gaskets, True Union Clamps, End Caps, Sight Caps, Elbow Sweeps, Concentric Reducers, Heavy-Duty Clamps, Siphon Tubes, Rotary Spray Jet, Mounting Apparatus for Spray Jet Nozzle, Sani-Sampling Devices, 1-inch Ladish Charging Elbow

Proper Placement and Autoclave Instructions 27

Putting It All Together 28

Bulk Storage Tanks

Bulk Storage Tanks 29-35

Blowers

Blowers Introduction 36

Blower Performance Curves 37-38

Four Steps to Blower Selection 39

Blower Specifications 40-44



How To Select Your High-Performance Tank

Tank Resin Selection Guide — Typical Properties and Applications¹

Material RESIN	General Chemical Resistance	Stress-Crack ² Resistance	Maximum Service Temperature	Brittleness Temperature	Impact Resistance ³	Can Be Welded (Hot Gas)	Food-Grade Acceptability NATURAL, UNPIGMENTED	Color NATURAL, UNPIGMENTED
HDPE High Density Polyethylene	Very Good	Good	140°F 60°C	-94°F -70°C	Good	Yes	Yes ⁴ Natural and Black	White
XLPE Cross-Linked High Density Polyethylene	Very Good	Excellent	140°F 60°C	-180°F -118°C	Excellent	No	No	Yellow
PP Polypropylene	Very Good	Excellent	220°F 104°C	32°F 0°C	Fair	Yes	Yes ⁴	Off-White
PVDF Polyvinylidene Fluoride	Excellent	Excellent	230°F 110°C	-40°F -40°C	Fair	Yes	Yes ⁴	Off-White

Tank Resin Selection Guide — (continued)

Material RESIN	ADVANTAGES AND APPLICATIONS			DO NOT USE WITH:
HDPE High Density Polyethylene	<ul style="list-style-type: none"> •Hard, smooth finish •Good temperature resistance •Less expensive than stainless steel or fiberglass 	<ul style="list-style-type: none"> •Storing caustics •Metal finishing •Storing organic and inorganic acids •Water treatment 	<ul style="list-style-type: none"> •Dispensing lab and photo chemicals •Plating •Brine 	Strong oxidizing agents, aromatic hydrocarbons, halogenated-aliphatic hydrocarbons, liquefied petroleum gas, solvents
XLPE Cross-Linked High Density Polyethylene	<ul style="list-style-type: none"> •Suitable for many corrosives not handled by FRP •Storing corrosives, including sulfuric, hydrochloric and hydrofluoric acids 	<ul style="list-style-type: none"> •Storing sodium hypochlorite (See statement on page 38) •Storing organic and inorganic chemicals and compounds 	<ul style="list-style-type: none"> •Chemical processing •Storing boiler treatment chemicals •Water and wastewater treatment 	Strong oxidizing agents, aromatic hydrocarbons, halogenated-aliphatic hydrocarbons, liquefied petroleum gas, solvents
PP Polypropylene	<ul style="list-style-type: none"> •Good resistance to many organic chemicals •Less expensive than comparable stainless steel tanks 	<ul style="list-style-type: none"> •Weldable PP fittings available •Plating and pickling lines •Sanitary process tanks 	<ul style="list-style-type: none"> •Etch tanks for processing silicone wafers 	Strong oxidizing agents; aromatic or chlorinated hydrocarbons, sub-freezing temperatures
PVDF Polyvinylidene Fluoride	<ul style="list-style-type: none"> •Superior resistance to inorganic acids, strong oxidizing agents and halogenated compounds •High-purity; does not contaminate process fluids •PVDF Schedule 80 threaded fittings available 	<ul style="list-style-type: none"> •Etch tanks for processing silicone wafers •Ultra-pure water storage (not potable) •Precious metal recovery •Storing and processing halogenated compounds (i.e., bromine) 	<ul style="list-style-type: none"> •Storing bleach and sulfuric acid for pulp and paper processing •Industrial battery casings •Insecticide manufacturing 	Ketones, esters and hot, concentrated caustics; nascent chlorine gas and concentrated caustic soda

NOTES:

1 At low temperatures, protect all tanks from impact. Below 40°F/4°C, specify XLPE Tanks.

2 Cross-linked, high-density polyethylene is recommended for use with stress-cracking agents.

3 Brittleness temperature per ASTM test D-746. The impact resistance of most rotomolded tanks declines at freezing temperatures. Cross-linked, high-density polyethylene tanks are well suited for cold storage.

4 The resins used in Saint-Gobain Performance Plastics linear low- and high-density polyethylene and polypropylene tanks comply with 21 CFR Regulation 177.1520. Polyethylene meets all food-grade requirements; however, this product is restricted to contacting food only of the types identified in 21 CFR 176.170 Table 1, under categories 1, IV-B, VII-B, VIII, and under conditions of use B through H described in Table 2 of 21 CFR 176.170. Saint-Gobain rotomolded polypropylene complies with FDA 21 CFR 177.1520 (c) 3.1 regulation. The resin used in PVDF tanks complies with 21 CFR 177.2510.

5 Open-top tanks do not contain UV stabilizer; black is recommended for certain applications. Bulk tanks are UV-stabilized and may be used outdoors.

General Guide to Open-Top Tanks

Plastic Tanks For High-Purity Storage

Saint-Gobain Performance Plastics high-performance tanks are the best and toughest in the industry. Exacting CAD-based designs, the highest quality virgin resins and tough construction provide excellent solutions for general purpose applications. The tanks are translucent and feature molded-in graduations.

Each tank comes with a matching cover the same thickness as the wall. The open-top unit covers fit like a shoe box; bolted or welded covers are available upon request.

Closed-dome tanks are available for applications requiring a completely closed vessel. The 6" threaded polypropylene covers prevent evaporation and spills.

Our open-top tanks are rated for use with 1.8 specific gravity media. If a

fiberglass casing is used, the rating goes up to 2.2. Casings provide structural support and prevent bulging at the bottom of the tank. They should be used with rectangular units with any dimension greater than 18 inches. Casings are also required for use with media having a specific gravity greater than 1.8 or for use at prolonged elevated temperatures.

Our stands, mixers, and casings have been pre-engineered for compatibility. Simply choose your tank size and the size codes of the accessories will match.

Fabrication is available for all Saint-Gobain Performance Plastics tanks. Modifications can be made to the covers or the sides. Contact customer service for quotations. Welded and mechanical fittings can be installed, as well as a full line of accessories.



Materials Overview

High Density Polyethylene (HDPE):	Cross-Linked Polyethylene (XLPE):
<ul style="list-style-type: none"> • FDA 21 CFR 177.1520 • Hard, Smooth Finish • Very Good Chemical Resistance • Good Stress-Crack Resistance • Max Service Temp—140°F • Translucent White 	<ul style="list-style-type: none"> • Not FDA • Cannot be welded • Better Chemical Resistance to HDPE • Excellent Stress-Crack Resistance • Max Service Temp—140°F • Yellow (Bulk Tanks—Gray)
Polypropylene (PP):	Polyvinylidene Fluoride (PVDF):
<ul style="list-style-type: none"> • FDA 21 CFR 177.1520 • USP Class VI, Non-cytotoxic • Hard, Smooth Finish • Very Good Chemical Resistance • Excellent Stress-Crack Resistance • Max Service Temp—220°F • White 	<ul style="list-style-type: none"> • FDA 21 CFR 177.2510 • High-Purity Material/Low Extractables • Larger sizes require casings • Inherent UV Resistance • Excellent Chemical Resistance • Max Service Temp—230°F • Off-White

Maximum service temperature listings refer to temperatures that should not be exceeded for the materials utilized in the specific product line. Many factors including media, specific gravity of media, external stresses, product geometry, environment, and others affect suitability of material.

Structural Designs

Cylindrical tanks feature a stepped-flange design that adds rigidity and strength while helping to contain drips. Tanks over 30 gallons feature a slightly raised bottom that channels liquids to tank walls and fittings. Spoked bottoms reinforce larger tanks over 55 gallons and provide near-total drainage.

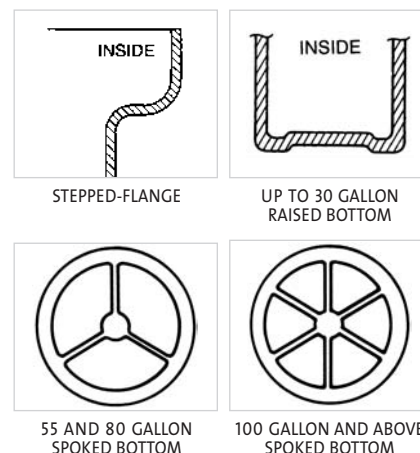

Flat-Bottom Cylindrical Tanks

Flat-Bottom Cylindrical Tanks

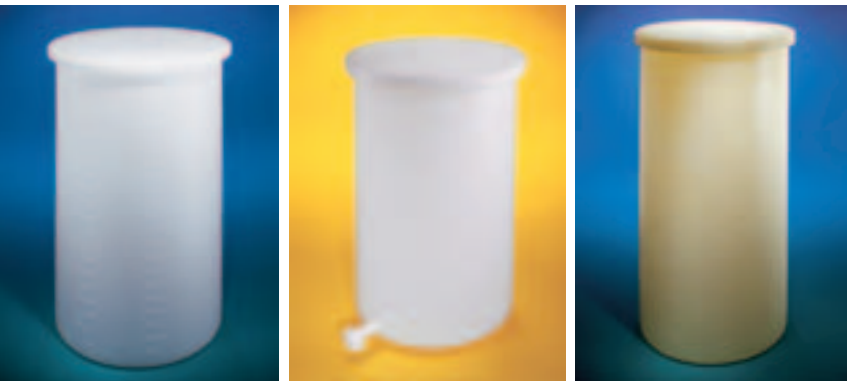

CAT. NO. 11100

CAT. NO. 11102

CAT. NO. 11300

- All tanks come with covers
- Brim capacity 10% over

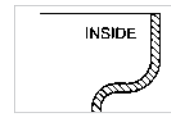

STEPPED-FLANGE



1000-GALLON COVER

WARNING: Never use FRP casings alone as a tank. Always use a liner. For continuous service at elevated temperatures or storage of high specific-gravity materials, always use an FRP casing with your tank.

Nominal Wall Thickness By Resin				HDPE, Heavyweight (Avail. in Black, No. 18100)		HDPE, Lightweight		XLPE, Heavyweight (Avail. in Black, No. 18300)	PP, Heavyweight (Avail. in Black, No. 18200)	PVDF	Approx. Shipping (wt., lbs.)		
Size (gallons)	Size Code	Grad. (gal./liter)	Nom. Tank Dimensions (O.D. x Depth, in.) <small>(CASING DIM.)</small>	Natural Cat. No. 11100	w/ Spigot Cat. No. 11102**	Natural Cat. No. 54100	Natural Cat. No. 54102	Natural Cat. No. 11300	Natural Cat. No. 11200	Natural Cat. No. 11500	Tank		w/Casing 19000
										Light	Heavy		
5	-0005	0.5/2	11 x 15 —	3/16	3/16	3/32	3/32	3/16	3/16	3/32	4-1/2'	5'	N/A
7.5	-0007	0.5/*	12 x 18 —	3/16	3/16	3/32	3/32	3/16	3/16	N/A	6-1/2'	7-1/2'	N/A
10	-0010	1/*	13 x 20 —	3/16	3/16	3/32	3/32	3/16	3/16	3/32	6-1/2'	9'	N/A
15	-0015	1/4	13 x 27 —	3/16	3/16	3/32	3/32	3/16	3/16	3/32	8'	11-1/2'	N/A
30	-0030	2.5/10	18 x 30 19-1/8 x 30-1/4	3/16	3/16	3/32	3/32	3/16	3/16	3/32	12'	19'	42'
55	-0055	2.5/10	22 x 36 23 x 36-1/4	1/4	1/4	3/32	3/32	1/4	1/4	1/8	20-1/2'	31	53
80	-0080	5/20	24 x 48 24-3/4 x 48-1/4	1/4	N/A	N/A	N/A	1/4	1/4	1/8**	N/A	50	80
100	-0100	5/20	28 x 44 29-3/16 x 44-1/4	1/4	N/A	N/A	N/A	1/4	1/4	1/8**	N/A	50	80
150	-0150	10/40	31 x 49 32-7/16 x 49-1/4	1/4	N/A	N/A	N/A	1/4	1/4	1/8**	N/A	60	135
200	-0200	25/200	36 x 51 37-1/2 x 51-1/4	1/4	N/A	N/A	N/A	1/4	1/4	1/8**	N/A	67-1/2	150
275	-0275	25/100	42 x 49 43-1/2 x 49-1/4	1/4	N/A	N/A	N/A	1/4	1/4	1/8**	N/A	101	200
360	-0360	25/100	48 x 49 48-3/8 x 49-1/4	1/4	N/A	N/A	N/A	1/4	1/4	N/A	N/A	120	296
500	-0500	25/100	53 x 62 54-1/8 x 62-1/4	5/16	N/A	N/A	N/A	5/16	N/A	N/A	N/A	150	300
1,000	-1000	50/250	66 x 72 67-1/2 x 72-1/4	7/16	N/A	N/A	N/A	7/16	N/A	N/A	N/A	389	500
Maximum Service Temperature				140°F 60°C		140°F 60°C		140°F 60°C	220°F 104°C	230°F 110°C			

*7.5- and 10-gallon cylindrical tanks do not have liter calibrations

†Within UPS size restrictions

**Casing required

††These sizes quoted on request

For replacement spigot, see page 13

N/A=Not Available

Maximum service temperature listings refer to temperatures that should not be exceeded for the materials utilized in the specific product line. Many factors, such as chemical resistance, specific gravity, external stresses, product geometry, environment and many others affect the suitability of a particular product. For additional information, contact Saint-Gobain Performance Plastics.

Conical-Bottom Tanks

Conical-Bottom Tanks

- 30° cone angle (18° for 400 gallons, 45° for 500 gallons)
- Complete drainage
- Better dispersal of solids
- Easy installation of welded or bulkhead fittings
- HDPE and polypropylene resins comply with 21 CFR Reg. 177.1520 (Refer to chart on page 3)
PVDF 21 CFR 177.2510

- Require metal stands (see page 9)
- Clearance from the floor to bottom of the tank is 18 inches (12 inches on 10-gallon tank)

WARNING: Never use FRP casings alone as a tank. Always use a liner. Always use an FRP casing with your tank for continuous service at elevated temperatures, or storage of high specific-gravity materials.



CAT. NO. 16120

Conical-Bottom Cylindrical Tanks — Nominal Wall Thickness By Resin

Size (gallons)	Size Code	Grad. (gal./liter)	Nom./Dim. (O.D. x Depth*)	Bottom Flat Dia.	HDPE	XLPE	PP	PVDF	Casing	Approx. Shipping		
					Natural Cat. No. 16120	Natural Cat. No. 16320	Natural Cat. No. 16220	Natural Cat. No. 16520	17000	(wt., lbs. Tank)	(wt., lbs. Tank w/ Casing)	
10	-0010	1/5	13-1/4 x 23	3	5/32	5/32	5/32	3/32	N/A	10†	N/A	
30	-0030	2.5/10	18 x 35	3	3/16	3/16	3/16	3/32	3/32	18	37	
55	-0055	2.5/10	22 x 44	3	3/16	3/16	3/16	1/8	3/16	34	53	
100	-0100	5/20	32 x 38	5	1/4	1/4	1/4	1/8	3/16	48	95	
150	-0150	5/20	32 x 57	5	1/4	1/4	1/4	1/8**	3/16	82	150	
250	-0250	25/100	43 x 54	5	5/16	5/16	5/16	1/8**	3/16	112	241	
400	-0400	25/100	56 x 52	7	3/8	3/8	3/8	N/A	1/4	140	230	
500	-0500	25/100	53 x 80	7	5/16	5/16	N/A	N/A	1/4	215	331	
Maximum Service Temperature					140°F 60°C	140°F 60°C	220°F 104°C	230°F 110°C				

*To cone flat N/A = Not Available

**Casing required

†Within UPS size restrictions

Cone Angles: 30° on 10, 30, 55, 100, 150, 250 gallon
18° on 400 gallon & 45° on 500 gallon



TANKS WITH CASING

Rectangular Tanks

A Complete Line of Rectangular Plastic Tanks from 2 to 500 Gallons



Used in Many Applications

Saint-Gobain Performance Plastics rectangular tanks have proven reliable in many demanding applications:

- Plating
- Etching
- Silicon wafer processing
- Circuit board production
- Photofinishing
- Food handling (except XLPE)
- Dry cleaning
- Metal parts degreasing
- Chemical processing
- Wastewater treatment
- Photographic applications

FRP (fiberglass-reinforced polyester) support casings are available for Saint-Gobain rectangular tanks. These casings are chemical-resistant and maintenance-free. Saint-Gobain Performance Plastics recommends using FRP casing or exterior support with all rectangular tanks used at elevated temperatures, with high specific gravity liquids or a dimension greater than 18 inches.

Choice of Four Premium Resins

Our rectangular tanks are available in four premium resins: HDPE, XLPE, PP and PVDF. More than 50 configurations and three flange styles are offered. All rectangular tanks are rotationally molded in one piece. There are no fabricated seams that are prone to stress-cracking and failure. Molded tanks cost less than fabricated plastic tanks or stainless steel tanks of the same size. All rectangular tanks are supplied with cover.

These tanks offer a broad range of resistance to chemicals, stress-cracking, impact and abrasion, depending on the resin. (See the *Tank Resin Selection Guide*.) A wide variety of welded and bulkhead-style fittings are available (see pages 12-13).

NOTE: Maximum service temperature listings refer to temperatures that should not be exceeded for the materials utilized in the specific product line. Many factors, such as chemical resistance, specific gravity, external stresses, product geometry, environment and many others affect the suitability of a particular product. For additional information, contact Saint-Gobain Performance Plastics.

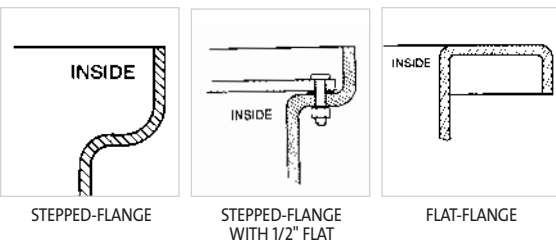

Tank Flange Styles Available

Stepped-Flange

- Easy mounting of small accessories
- Better drip containment of parts that are dipped

Stepped-Flange With 1/2" Flat

- To secure equipment support covers

- Stock tank comes with standard dust cover only; cover, bolts and gasket custom quote

Flat-Flange

- Often used in plating operations
- When ordered with FRP support casings, each tank can support up to 300 lbs. (i.e., plating rods)

Tanks With Flat Wide Flange

Nominal Interior Dimensions Inches, L x W x Depth	Size (gallons)	Stand Size Code	HDPE	PP	XLPE	Casing	Approx. Shipping (wt., lbs.) Tank w/ Casing	
			Cat. No. 14150	Cat. No. 14250	Cat. No. 14350	Cat. No. 15000		
24 x 12 x 12	15	-0020	5/32	1/4	5/32	3/16	13 [†]	33
24 x 18 x 18	30	-0045	5/32	1/4	5/32	3/16	20 [†]	35
Maximum Service Temperature			140°F 60°C	220°F 104°C	140°F 60°C			

*Casing recommended

† Within UPS size restrictions

Rectangular Tanks

Rectangular Tanks — Nominal Wall Thickness By Resin

Nominal Interior Dimensions Inches, L x W x Depth	Size (gallons)	Stand Size Code	HDPE	XLPE	PP	PVDF	LLPE	XLPE	Casing	Approx. Shipping (wt., lbs.) Tank w/ Casing	
			Cat. No. 14100	Cat. No. 14300	Cat. No. 14200	Cat. No. 14500	Cat. No. 12000 FLAT FLANGE	Cat. No. 12300 FLAT FLANGE	Cat. No. 15000 THICKNESS		
8 x 8 x 8	2	-0002	5/32	5/32	3/16	3/32	—	—	3/16	4'	10
14 x 10 x 10	6	-0005	5/32	5/32	3/16	3/32	—	—	3/16	7'	16
12 x 12 x 12	7	-0010	5/32	5/32	3/16	3/32	—	—	3/16	8'	15
18 x 12 x 12	11	-0015	5/32	5/32	3/16	1/8	—	—	3/16	10'	22
24 x 12 x 12*	15	-0020	5/32	5/32	3/16	1/8	—	—	3/16	13'	33
24 x 24 x 12*	30	-0021	5/32	5/32	3/16	1/8	—	—	3/16	19'	78
30 x 30 x 12*	47	-0022	5/32	5/32	1/4	N/A	—	—	3/16	32	67
30 x 24 x 12*	30	-0006	—	—	—	—	7/32	7/32	3/16	35'	57
48 x 24 x 12*	50	-0011	—	—	—	—	7/32	7/32	3/16	49	71
18 x 4 x 18	6	-0030	5/32	5/32	3/16	N/A	—	—	3/16	8'	20
12 x 12 x 18	11	-0035	5/32	5/32	3/16	N/A	—	—	3/16	11'	20
18 x 12 x 18	15	-0040	5/32	5/32	3/16	1/8	—	—	3/16	13'	26
18 x 18 x 18	25	-0042	5/32	5/32	1/4	N/A	—	—	3/16	18'	36
24 x 12 x 18*	22	-0043	5/32	5/32	1/4	N/A	—	—	3/16	17'	44
24 x 18 x 18*	30	-0045	5/32	5/32	1/4	1/8	—	—	3/16	25'	35
30 x 24 x 18*	50	-0016	—	—	—	—	7/32	7/32	3/16	38	58
48 x 24 x 18*	75	-0023	—	—	—	—	7/32	7/32	3/16	50-1/2	78
36 x 20 x 20*	60	-0050	5/32	3/16	1/4	1/8	—	—	3/16	41	76
18 x 12 x 24*	22	-0060	5/32	5/32	1/4	1/8	—	—	3/16	15'	41
12 x 12 x 24*	30	-0062	5/32	5/32	1/4	N/A	—	—	3/16	19'	52
24 x 18 x 24*	45	-0065	5/32	5/32	1/4	1/8	—	—	3/16	24	65
18 x 18 x 24*	94	-0066	3/16	3/16	5/16	N/A	—	—	3/16	46	85
24 x 12 x 24*	90	-0070	3/16	3/16	1/4	N/A	—	—	3/16	45	68
24 x 24 x 24*	60	-0025	—	—	—	—	7/32	7/32	3/16	42	82
30 x 24 x 24*	70	-0031	—	—	—	—	7/32	7/32	3/16	43	88
48 x 24 x 24*	105	-0036	—	—	—	—	7/32	7/32	3/16	62	119
24 x 4 x 30*	12	-0075	1/8	1/8	3/16	N/A	—	—	3/16	17'	25
24 x 8 x 30*	25	-0080	1/8	1/8	3/16	N/A	—	—	3/16	18'	30
30 x 30 x 30*	117	-0081	3/16	3/16	5/16	N/A	—	—	3/16	47	98
18 x 18 x 30*	40	-0041	—	—	—	—	7/32	7/32	3/16	29	71
24 x 18 x 30*	55	-0046	—	—	—	—	7/32	7/32	3/16	41	84
30 x 24 x 30*	85	-0051	—	—	—	—	7/32	7/32	3/16	53-1/2	104
30 x 30 x 30*	115	-0055	—	—	—	—	7/32	7/32	3/16	60	119
48 x 24 x 30*	135	-0061	—	—	—	—	7/32	7/32	3/16	72	138
44 x 36 x 33**	220	-0067**	—	—	—	—	5/16	5/16	3/16	120	165
50 x 36 x 33**	250	-0071**	—	—	—	—	5/16	5/16	3/16	138	213
24 x 24 x 36*	90	-0090	3/16	3/16	1/4	N/A	—	—	3/16	45	80
30 x 30 x 36*	140	-0091	3/16	3/16	5/16	N/A	—	—	3/16	50	135
30 x 24 x 36*	105	-0076	—	—	—	—	7/32	7/32	3/16	65	122
36 x 36 x 36*	185	-0082	—	—	—	—	7/32	7/32	3/16	98	216
48 x 24 x 36*	160	-0085	—	—	—	—	7/32	7/32	3/16	76	190
48 x 36 x 36**	260	-0087**	—	—	—	—	5/16	5/16	3/16	153	263
60 x 24 x 36**	210	-0092**	—	—	—	—	5/16	5/16	3/16	157	222
72 x 36 x 36**	375	-0095**	—	—	—	—	5/16	5/16	3/16	194	309
30 x 24 x 48*	140	-0100	—	—	—	—	7/32	7/32	3/16	73	162
48 x 24 x 48**	220	-0105	—	—	—	—	7/32	7/32	3/16	93	173
72 x 36 x 48**	500	-0110**	—	—	—	—	5/16	5/16	3/16	186	386
Maximum Service Temperature			140°F 60°C	140°F 60°C	220°F 104°C	230°F 110°C	140°F 60°C	140°F 60°C			

*Casing recommended

**Casing required

†Within UPS size restrictions

††Covers on these tanks are ribbed for structural support. Cross support cannot be cut for hinge installation.

Cylindrical Tanks

Tapered General Purpose Containers



CAT. NO. 56104

Tapered General Purpose Container—HDPE

- Straight, no-lip flange
- Often used in water treatment
- Rigid and lightweight
- Fits through standard door for portability

Size (gallons)	Size Code	Grad. (gallons)	Nom./Dim. (O.D. x Depth)	Natural Cat. No. 56104	Approx. Shipping (wt., lbs.)
30	-0030	5	22 x 22-1/2	3/32	55
50	-0050	5	22 x 38-7/8	3/32	80

5 per package.

Closed-Dome Tanks



CAT. NO. 11150

Closed-Dome Tanks

- 6" threaded screw closure with silicone gasket
- 2-inch top bung with buttress thread on HDPE, 2-inch NPS on PP

- Protects contents from contamination and spillage
- Reduces evaporation
- Two mounting flats
- Domed bottom offers good drainage
- Graduations in gallons and liters

Accessories and Options

- Viton closure gasket #620409-0005
- EPDM gasket 311-1509
- Metal stand elevates tanks 22 inches from floor—Cat. No. 19009 (see page 9)
- Many fittings available (see pages 12-13)

Closed-Dome Tanks — Nominal Wall Thickness By Resin

Size (gallons)	Size Code	Grad. (gal./liter)	Nom./Dim. (O.D. x Depth)	HDPE	PP	Approximate Shipping (wt., lbs.)
				Natural Cat. No. 11150	Natural Cat. No. 11250	
20*	-0020	1.25/5	16-1/2 x 32	1/4	N/A	17†
30	-0030	2.5/10	18-1/2 x 38-5/8	3/16	1/4	20†
55	-0055	2.5/10	22 x 43-1/8	1/4	1/4	31
100	-0100	10 /50	28-1/2 x 51-1/4	1/4	5/16	60

*Flat sides 180° for fitting placement. No flat on top.

†Within UPS size restrictions

For stainless steel dolly, see page 19.

Cylindrical Tank Stands

Tank Stands

Sturdy, all-metal stands are available for most Saint-Gobain Performance Plastics cylindrical tanks. These stands feature:

- Welded carbon steel construction
- Chemical-resistant PUR Paint
- Fit tanks with or without FRP casing

Floor Stands

- Used with flat-bottom tanks
- Elevate the mixer to correct height
- Stand partially encircles the tank
- Should be bolted to the floor for stability

Elevated Stands for Flat-Bottom Tanks

- Lift flat-bottom tanks 22 inches
- 8-inch center hole for drain
- 5.5-inch rim cut-out for low side fittings
- Stand should be bolted to the floor
- Available with or without mixer supports

Elevated Stands for Conical-Bottom Tanks

- Conform to the tank's cone angle
- Open at tip to accommodate fittings
- Conical-bottom stands center drain openings are as follows:
30 gallon—5 inch;
55, 100, 150 and 250 gallon—7 inch;
400 and 500 gallon—8 inch
- Cone tip 18 inches from the floor
- Stand should be bolted to the floor
- Available with or without mixer supports

Options

- Casters (S/S or sanitary)
- 304 or 316 S/S construction
- Handles and support ring for mobile stands



FLOOR STAND FOR FLAT-BOTTOM TANK STAND CAT. NO. 20010 (UP TO 1000 GALLONS)

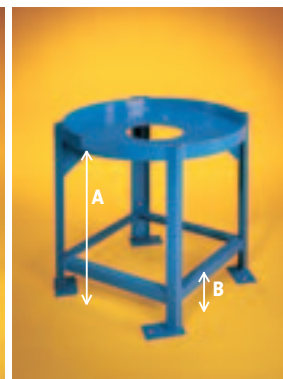

ELEVATED FLAT-BOTTOM TANK STAND CAT. NOS. 19009 AND 19010 (UP TO 1000 GALLONS)

NOTE: Plastic tanks cannot support the weight of a mixer or other equipment. They must be attached to the stand's metal support. NEVER clamp equipment directly to a plastic tank.

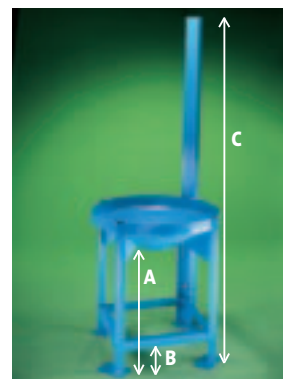

ELEVATED CONICAL-BOTTOM TANK STAND CAT. NOS. 17109 AND 17110 (UP TO 500 GALLONS)

Tank Stands — Nominal Dimensions, Inches

Size (gallons)	Stand Size Code	Floor Stands Flat-Bottom Cat. No. 20010 (w/ Support)	Elevated Stands						Stand Shipping (wt., lbs.)	
			Flat-Bottom			Conical-Bottom			Floor	Elevated
			Cat. No. 19009 A	Cat. No. 19010 B	Cat. No. 19010 C (w/ support) SUPPORT HEIGHT	Cat. No. 17109 A	Cat. No. 17110 B	Cat. No. 17110 C (w/ support)		
10	-0010	N/A	N/A	N/A	N/A	12	3-1/2	N/A	N/A	25
30	-0030	35	22	3-1/2	57	18	3-1/2	56-1/2	17-1/2	85
55	-0055	38	22	3-1/2	61	18	3-1/2	63	20	95
80	-080	48	22	3-1/2	73	N/A	N/A	N/A	23	105
100	-0100	44	22	3-1/2	68	18	3-1/2	64	27-1/2	125
150	-0150	49	22	3-1/2	73	18	3-1/2	78	29	135
200	-0200	51	22	3-1/2	73	N/A	N/A	N/A	32-1/2	150
250	-0250	N/A	N/A	N/A	N/A	18	3-1/2	74	N/A	158
275	-0275	49	22	3-1/2	73	N/A	N/A	N/A	32	182
360	-0360	49	22	3-1/2	73	N/A	N/A	N/A	36	215
400	-0400	N/A	N/A	N/A	N/A	18	3-1/2	73	N/A	265
500	-0500	62	22	3-1/2	84	18	9-1/2	105	43	275
1000	-1000	77	22	3-1/2	100	N/A	N/A	N/A	52-1/2	325

For dimensions of floor pads and bolt holes, contact Saint-Gobain Performance Plastics.

Open-Top Tank Mixers

Saint-Gobain Performance Plastics Tanks and LIGHTNIN Mixers



LIGHTNIN MIXER

Our pre-engineered packages are available for general mixing/medium agitation of up to 1000 gallons.

Saint-Gobain Performance Plastics tank and mixer packages are designed for liquids and liquid slurries only. We do not warrant these packages for any specific application; only general purpose mixing to these maximum limits:

- Solids—20% by weight
- Specific Gravity (batch)—1.2
- Viscosity—500 centipoise

LIGHTNIN Mixer Features

- Self-aligning, floating gears optimize load sharing and reduce wear
- Switch cord and plug are standard on single-phase units

- Oversized bearings for superior shaft support
- 115-volt, single-phase motors
- Standard 1-year warranty
- Permanently sealed lubrication
- **Motors**—Precision-matched to LIGHTNIN mixers. Direct drive or gear drive, depending on tank size. Chemical-resistant housings, 1/4–1/2 hp. Pre-engineered to applicable Saint-Gobain tanks and stands. Totally enclosed.
- **Mounts**—LIGHTNIN mixers clamp securely to steel support stands.
- **Mixer Supports**—Welded steel with chemical-resistant polyurethane paint. Pre-sized for proper mixer elevation. Integral part of stand for security and rigidity.
- **Impellers**—Cast 316 stainless steel impellers are supplied on all mixers. Mixer packages are supplied with one impeller.
- **Shafts**—All shafts are concentric, centerless ground, stainless steel.

Available Options

- Explosion-proof motors
- LIGHTNIN mixers can be supplied with air motors for use in flammable or explosion-proof environment.
- Air motors operate using compressed air and require no electricity. These mixers provide an inherent variable-speed feature by merely adjusting your air-control valve and cannot overload
- Tachometers for mixers larger than 55 gallons
- Special PVDF and PTFE shafts and impeller coatings

WARNING: Never clamp a mixer directly to a plastic tank. Always attach the mixer to a separate metal support. Directly attaching a mixer to a plastic tank will void all product warranties. Never position impeller closer than 3 inches from tank wall.

Flat-Bottom and Conical-Bottom Tanks with Mixers

FLAT-BOTTOM

Mixers, Cat. No. 63100

Tank Size (gallons)	Size Code	Mixer Drive	Horse Power	Impeller RPM	Shaft D x L, in.	Impeller Dia., in.	Mixer Height, in.	Tank, Stand and Mixer Approx. Shipping (wt., lbs.)
30	-0030	Direct	1/4	1750	0.63 x 36	3.6	13	200
55	-0055	Direct	1/4	1750	0.63 x 36	3.6	13	215
80	-0080	Direct	1/4	1750	0.63 x 48	3.6	25-1/2	270
100	-0100	Direct	1/4	1750	0.63 x 48	3.6	25-1/2	285
150	-0150	Direct	1/4	1750	0.63 x 48	3.6	25-1/2	350
200	-0200	Gear	1/4	350	0.75 x 48	11.2	29-1/4	440
275	-0275	Gear	1/4	350	0.75 x 48	11.2	29-1/4	535
360	-0360	Gear	1/4	280	0.75 x 48	13.6	29-1/4	580
500	-0500	Gear	1/4	280	0.75 x 60	13.6	29-1/4	750
1000	-1000	Gear	1/2	280	0.75 x 70	15.1	29-1/4	1000

CONICAL-BOTTOM

Mixers, Cat. No. 63600

Tank Size (gallons)	Size Code	Mixer Drive	Horse Power	Impeller RPM	Shaft D x L, in.	Impeller Dia., in.	Mixer Height, in.	Tank, Stand and Mixer Approx. Shipping (wt., lbs.)
10	-0010	N/A	N/A	N/A	N/A	N/A	N/A	N/A
30	-0030	Direct	1/4	1725	0.63 x 36	3.6	13	170
55	-0055	Direct	1/4	1725	0.63 x 36	3.6	13	210
100	-0100	Direct	1/4	1725	0.63 x 42	3.6	25-1/2	285
150	-0150	Gear	1/4	350	0.75 x 54	11.2	19-1/8	359
250	-0250	Gear	1/4	350	0.75 x 48	8.9	29-1/4	500
400	-0400	Gear	1/4	350	0.75 x 50	11.2	29-1/4	540
500	-0500	Gear	1/4	280	0.75 x 70	12.8	29-1/4	650

NOTE: Add mixer height to agitator support dimension (page 8) for overall height.

Open-Top Tank Fittings/Accessories

Covers

Floating Covers

Maintain continuous contact as liquid level changes; reduce evaporation, fumes and surface oxidation. Very good chemical resistance. Fit only Saint-Gobain Performance Plastics straight-wall cylindrical tanks (Series 11000, 18000, 19000 and 54000). Resin complies with 21 CFR Reg. 177.1520. Refer to chart on page 2.

Installed Hinges for Saint-Gobain Performance Plastics High-Performance Cylindrical Tank Covers

Flexible PP hinge provides access to cylindrical tanks without completely removing cover. The cover is cut to your specifications. The hinge is installed with stainless steel rivets. Hinge length and exact location must be listed separately on your purchase order.

Stainless steel hinges available upon request.



FLOATING COVER
CAT. NO. 54104

HDPE Floating Covers for Saint-Gobain Performance Plastics Cylindrical Tanks— Nominal Wall Thickness

Fits These Size Tanks (gallons)	Size Code	Diameter (inches)	Floating Cover (thickness, inches)
5	-0011	10-3/8	1/16
7.5	-0012	12	1/16
10	-0013	12-3/4	1/16
15	-0014	13-1/8	1/16
30	-0018	18-1/8	3/32
55	-0022	21-1/2	3/32

These covers do not fit Saint-Gobain tanks Cat. No. 56104.

Installed Hinges for Saint-Gobain Performance Plastics High-Performance Tanks— Nominal Wall Thickness

Hinges available for all open-top vessels.

Fits These Size Tanks (gallons)	Hinges for Covers Cat. No. 87500	Hinge Length (inches)
5 to 80	-0024	up to 24
100 to 200	-2536	25 to 36
275 and 360	-3748	37 to 48
500	-4960	49 to 60

Use the size to determine P/N for rectangular tanks. Some rectangular covers have ribs which may limit hinge placement. See page 7 for details.

Open-Top Tank Fittings/Accessories

Installed and Loose Fittings

Welded Options



A. FULL COUPLING, B. FLANGED COUPLING, C. HALF NIPPLE, D. HALF COUPLINGS, E. FLANGED COUPLING W/O SIDE SUPPORTS

Loose Accessories



F. SIGHT GAUGE ASSEMBLY, G. CLOSE NIPPLE, H. FEMALE BALL VALVE, I. TUBING ADAPTER, J. SPIGOT

Bulkhead Fittings

Bulkhead Fitting Installation

See pages 14-16 for additional information.

Tank Diameter Minimums

Bulkhead Size (inches)	Min. Tank I.D. (inches)
1/2	7.25
3/4	10.00
1	11.75
1-1/4	16.25
1-1/2	16.25
2	25.75
3	42.50
4	90.00



K. BULKHEAD FITTING AND L. VITON® GASKET

For Open-Top Tanks

INSTALLED FITTINGS, WELDED (Sanitary options see page 24)

Welded fittings must be of the same resin as the tank on which they will be installed.

Fittings cannot be welded to XLPE tanks.

Size Code and Availability (X)

Fitting	Material	B=Black N=Natural	Cat. No.	-0025 (1/4")	-0050 (1/2")	-0075 (3/4")	-0100 (1")	-0125 (1-1/4")	-0150 (1-1/2")	-0200 (2")	-0300 (3")	-0400 (4")	-0600 (6")
A. Full Couplings, Female Threads	PE	B	87005	—	X	X	X	—	X	X	X	X	—
	PP	N	89005	—	X	X	X	—	X	X	—	—	—
	PVDF	N	87006	—	X	X	X	—	X	X	—	—	—
Specify installation with one end flush inside of tank, or half in/half out. Coupling will be installed half in/half out unless otherwise specified. For room temperature service only. Specify nipples for service above 70°F/21°C and below 140°F/60°C.													
B. Flanged Couplings w/ HDPE Flange (Available with or without side supports)	PE	B	93400	—	X	X	X	—	X	X	X	X	X
HDPE flanges are one-piece, all-plastic with 150 lbs. ASA bolt pattern dimensions.													
Spigot, Needle-Type w/ Boss and Two Teflon TFE O-rings	PP Spigot w/ HDPE Boss	N	96423	—	—	—	X	—	—	—	—	—	—
For HDPE tanks up to 100 gallons. For larger tanks, use valves. PP spigots are installed on threaded HDPE boss, which is spin-welded onto tank at factory. Spigot has 1-1/8-12 straight female threads, 3/8 inch opening. Accepts 5/8 inch I.D. tubing. Boss fits only HDPE tanks.													
C. Half Nipples, Male Threads	PE	B	93857	—	X	X	X	—	X	X	X	X	—
	HDPE (FDA)	N	93859	—	X	X	X	—	X	X	—	—	—
	PP	N	95857	—	X	X	X	—	X	X	X	—	—
	PVDF	N	93858	—	X	X	X	—	X	X	—	—	—
D. Half Couplings, Female Threads	PE	B	93840	—	X	X	X	—	X	X	X	X	—
	PP	N	95840	—	X	X	X	—	X	X	—	—	—
	PVDF	N	93841	—	X	X	X	—	X	X	—	—	—
For room temperature service only. Specify nipples for above 70°F/21°C and below 140°F/60°C.													

Open-Top Tank Fittings/Accessories

For Open-Top Tanks

LOOSE FITTINGS, MECHANICAL

Size Code and Availability (X)

Fitting	Material	Cat. No.	-0025 (1/4")	-0050 (1/2")	-0075 (3/4")	-0100 (1")	-0125 (1-1/4")	-0150 (1-1/2")	-0200 (2")	-0300 (3")	-0400 (4")	-0600 (6")
F. Sight-Gauge Assembly	PE/PVC	96000 -0001	—	X	—	—	—	—	—	—	—	—
	Consists of PVC valves, fittings and translucent PE tubing (5/8 inch I.D. x 3/4 inch O.D.). Specify tubing length.											
G. Close Nipples	PVC	97103	—	X	X	X	X	X	X	X	X	—
	PP	98103	—	X	X	X	X	X	X	X	X	—
H. Ball Valves, Threaded	PVC	97003	—	X	X	X	X	X	X	—	—	—
	PP	98003	—	X	X	X	X	X	X	—	—	—
Female pipe thread on both ends. These valves must be supported. Installed with 93857 nipples, 97001 or 98001 bulkhead fittings and 97103 or 98103 close nipples. See page 23 for Sanitary Ball Valves.												
I. Tubing Adapter (Insert-type), Male Thread	PVC	97006	—	X	X	X	—	X	X	—	—	—
For Saint-Gobain Performance Plastics TYGON® tubing. Complete with stainless steel hose clamp.												
J. Spigot	PP	97424	—	—	X	—	—	—	—	—	—	—
With male 3/4 inch thread and neoprene seat gasket. Can be easily field-installed with bulkhead fitting. Requires 3/4 inch female National Pipe Thread (NPT) fitting for installation. For Tubing: PVC—3/8" I.D. to 9/16" I.D. (1/16 inch wall) PVC—9/16" to 5/8" I.D. (1/8-3/16 inch wall) LDPE—5/8" I.D. (1/16 inch wall) Not for use on tanks greater than 100 gallons												
Spigot, Needle-Type	PP	716421 -0010	X	—	—	—	—	—	—	—	—	—
Replacement spigot for Cat. No. 96423. Only fits on Saint-Gobain Performance Plastics-installed 1-1/8 x 12 inch straight threaded boss. Accepts 5/8 inch I.D. tubing.												
Quick-Action Spigot	PP	716422 -0010	X	—	—	—	—	—	—	—	—	—
Only fits on Saint-Gobain Performance Plastics-installed 1-1/8 x 12 inch straight threaded boss. Spigot accepts 5/8 inch I.D. tubing. Adapter accepts 1/4 or 5/16 inch I.D. tubing.												

INSTALLED FITTINGS, MECHANICAL

K. Bulkhead Fitting	PVC, Installed	87001	X	X	X	X	X	X	X	X	X	—
	PP, Installed	88001	X	X	X	X	X	X	X	X	X	—
	PVC, Loose	97001	X	X	X	X	X	X	X	X	X	—
	PP, Loose	98001	X	X	X	X	X	X	X	X	X	—
Bulkhead fittings are supplied with one EPDM gasket. All two-part fittings screw together through a hole cut in the tank. Other gasket materials are available at added cost.												
Flanged Adapter w/o Bulkhead Fitting	PVC	93420	—	—	—	X	—	X	X	X	X	—
F. Sight-Gauge Assembly	PE/PVC	INSTALLED 76000 -0001	—	—	—	X	—	—	—	—	—	—
Consists of PVC valves, fittings and translucent PE tubing (5/8 inch I.D. x 3/4 inch O.D.). Installed close to top and bottom of tank unless otherwise specified.												
L. Gaskets for PP and PVC Bulkhead Fittings	EPDM	48080	—	X	X	X	†	X	X	X	X	—
	VITON™	48090	—	X	X	X	†	X	X	X	X	—
*Where an additional gasket is needed, or as a replacement for original gasket. †1-1/2 inch gasket can be used on 97001-0125 and 98001-0125 bulkhead fittings.												

Guidelines for Installation

Fittings That Connect to Your System

Many types of fittings are available for piping into your Saint-Gobain Performance Plastics cylindrical tanks, including bulkhead fittings, valves, nipples, spigots and tubing adapters. They are available factory-installed or loose for field installation.

Welded fittings are factory-installed, in threaded or sanitary designs, and offer superior sealing integrity. Fittings can only

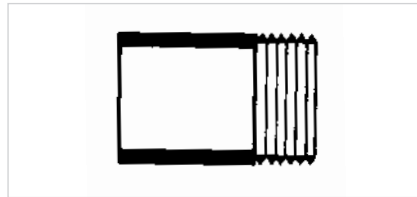

WELDED

be welded to tanks of the same material. XLPE tanks cannot be welded. See page 12.

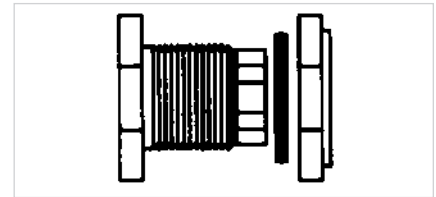

BULKHEAD

Bulkhead-type fittings offer mechanical seals with gaskets for factory or easy field installation. See page 13.

Guidelines for Factory-Installed Fittings

Before ordering a tank with factory-installed welded fittings, consider space constraints, tank elevation, whether indoor or outdoor use, location, building codes, safety regulations, piping and all other equipment that will be attached to the tank.

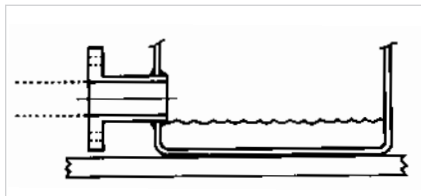

1. When a fitting is welded onto the side of a tank that is not elevated, complete drainage is impossible. This applies to flanges, spigots and bulkheads. Specify that the fitting's centerline must be as close as possible to the bottom of the tank. For maximum drainage, see following descriptions. For complete drainage, a conical tank should be used.

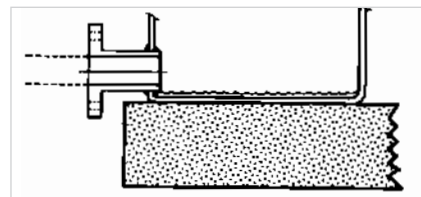

2. When tanks are elevated, welded fittings can be installed low on the tank wall, providing drainage to within 1/4-inch of the bottom (bulkheads vary with size). The bulkhead must not interfere with the support.

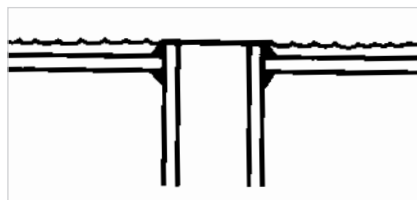

3. Fittings welded to tank bottoms will drain to within 1/8-inch of the bottom (bulkheads vary by size). The tank's foundation must have a cut-out or channel of the fitting and its piping.

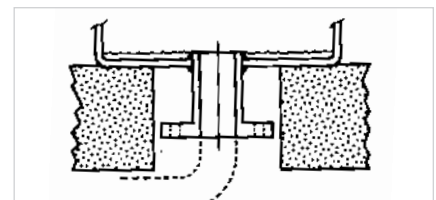

4. Welded fittings are not flush with tank bottom. This prevents complete drainage.

Installation and Use of Saint-Gobain Performance Plastics High-Performance Tanks

- Place the tank on a smooth, level surface, free of foreign objects. Maintain complete bottom support at all times, regardless of the type of tank. If outdoors, the site should be above any known flood plain and, if on soil, should be unsaturated, stable and compact.
- Tanks mounted on vehicles should be both chocked and secured to the vehicle platform. Do not put undue stress on tanks by over-tightening. Chocks must be secured by the platform on all four sides to prevent sliding.
- Support the sides of all unsupported rectangular tanks over 18 inches in length, width or depth. Casings are recommended.
- Mount agitators, heaters and other heavy equipment on independent structural members. The flanges of 13000-series Saint-Gobain tanks are designed to support plating equipment, up to 300 lbs. per tank.
- When piping is connected to a tank:
 - Weight of strainer, heavy shut-off valves or heavy pipe must be supported, not carried by the tank connection. Use expansion joints to provide relief from expansion and contraction of piping and prevent damage of fittings.
- All bulkhead fittings should be hand tightened and then given an additional half-turn. Excessive tightening may distort gaskets, causing leaks.
- Keep immersion heaters at least 1 inch from tank walls and bottom.

Guidelines for Installation

Installation and Use of Saint-Gobain Performance Plastics High-Performance Tanks (continued)

- Protect tanks from impact, particularly at temperatures below 40°F/4°C. For low temperature service, specify cross-linked high-density polyethylene tanks.
- Protect natural (white) tanks from direct sunlight. Black and/or UV-stabilized tanks are recommended for outdoor use. See “Technical Information” on page 37 of this catalog.
- Do not subject tanks to maximum operating temperatures exceeding those listed in the “Tank Resin Selection Guide” on page 2.
- Water test all plumbed-in tanks for a minimum of 5 hours before using. Plumbing leaks can then be identified and corrected.
- Flush all tanks well with water before using.
- Use tanks in accordance with the “Chemical Resistance Chart” on pages 39-44.

WARNING: All Saint-Gobain Performance Plastics tanks are designed for atmospheric storage of chemicals. They should not be used for pressure, vacuum or direct burial applications.

Fabrication Guide for Open-Top Tanks

1. Is complete drainage required?

Use conical-bottom tanks for complete drainage.

2. What type of fitting is required? (Refer to pages 12-13)

- sanitary (see page 24)
- welded
- mechanical (only type available for XLPE)

3. What size fitting is needed? (Refer to chart at right and also pages 12-13)

4. Accessories?

These may need to be taken into consideration when determining type, size, or placement of fittings.

5. Fitting placement?

Use line drawings provided to show fitting placement. Reference as many dimensions as possible, such as distance from the bottom, side or top of tank; distance from other fittings. Please label fittings with part number or description to avoid confusion.

6. Is a stand needed?

If a mixer is being used, a stand with support is required. Mixers, stands, and tanks have corresponding size codes (XXXXX-0250).

7. Is a casing required?

Casings provide structural support which may be necessary to prevent deformation of the bottom of the tank. Maximum specific gravity WITH a casing is 2.2. Without, it is 1.8. A casing is recommended on rectangular tanks having a dimension over 18". Fittings may be installed through the casing. Casings have corresponding size codes (XXXXX-0250)

Fittings Sizes

Conical Tank Size (gallons)	Max. Bulkhead on Cone Flat	Max. Bulkhead Fitting on Side
10	3/4"	1
30	3/4"	1.5
55	3/4"	1.5
100	2"	2
150	2"	2
250	2"	3
400	3"	3
500	3"	3

Flat-Bottom Tanks Size (gallons)	Max. Bulkhead Fitting on Side
5	1"
7.5	1"
10	1"
15	1"
30	1-1/2"
55	1-1/2"
80	1-1/2"
100	2"
150	2"
250	2"
275	3"
360	3"
500	3"
1000	3"

Putting It All Together

Lids

Hinged, slotted lids are available.
All tanks ship with a cover



Fittings

Can be installed on cover,
side and/or bottom of tank



Specify Outlet

Several valve options
are available



LIGHTNIN Mixer

Never clamp a mixer to the
side of the tank



Conical-Bottom Tank



Elevated Conical-Bottom Tank Stand



Sanitary Tanks

Sanitary Conical Tanks

Developed to address the special needs of the pharmaceutical and related industries, Saint-Gobain Performance Plastics Sanitary Process Vessels are manufactured from a special resin that allows the unit to withstand autoclaving. These tanks provide corrosion protection and also prevent metallic contamination. A low-cost alternative to metal, our sanitary tanks also offer complete drainage and a wide assortment of



compatible accessories. The units are made to each customer's unique process requirements. Sampling devices, spray jets, mixers, three drainage options, and specified fitting placement are just a few examples of the options available. Typical applications include buffer mixing, media preparations, and small scale production. Modifications can also be made to accommodate special size needs. The units are also completely compatible with Saint-Gobain Performance Plastics hoses, piping systems, and tubing products, helping to maintain Saint-Gobain Performance Plastics' reputation as a worldwide leader in the pharmaceutical, industrial, and life science industries.



SANITARY PROCESSING



SANITARY TANK FAMILY

Closed-Dome Bio Tanks

Closed-Dome Bio Tanks—Polypropylene; Polypropylene Closure



30- TO 100- GALLON SIZE WITH OVERHEAD MIXER SYSTEM



CAT. NO. 2650

Excellent for preparing media components and growing cultures. Closure and gasket material meet the specifications promulgated under the Federal Food, Drug and Cosmetic Act, for use involving contact with food for human consumption. Please refer to the specifications listed in Regulation 21 CFR177.1520(c) 3.1. Flat bottom on 75-liter size is ideal for use with magnetic stir bars. Large, 6-inch gasketed closures make filling and dispensing easy. Molded-in body grips

on 75-liter size provide safe, convenient handling. Flat areas on 115- to 380-liter size for easy fitting installation. Molded-in graduations in liter and gallon increments. Individually packaged.

NOTE: An overhead mixer system is also available (Cat. Nos. 2653, 2654) and requires sanitary mixer support (Cat. No. 2651-0200). Installed sanitary fittings are also available. See autoclavable dolly (Cat. No. 2624). **Autoclavable/Graduated/Leakproof.**

Cat. No. 2650	-0020	-0030	-0055	-0100
Capacity, liter; gallons	75; 20	115; 30	210; 55	380; 100
O.D. x Height, mm (nominal)	419 x 813	470 x 981	559 x 1099	724 x 1321
O.D. x Height, in. (nominal)	16-1/2 x 32	18-1/2 x 38-5/8	22 x 43-1/8	28-1/2 x 51-1/4
Wall Thickness, mm; in. (nominal)	6.3; 1/4	6.3; 1/4	6.3; 1/4	7.9; 5/16

Closed-Dome Bio Tank Accessories

Closed-Dome Bio Tank Closure with Mixer Support Assembly—Polypropylene, PVDF True Union Clamp

An overhead mixer support assembly 2651-0200 for use with all closed-dome bio tanks (Cat. No. 2650) and high-density polyethylene closed-dome tanks (Cat. No. 11150). The unique, sanitary flange assembly allows for overhead mixing in a closed system. Designed specifically for use with Saint-Gobain Performance Plastics BioTech mixing unit (Cat. Nos. 2653, 2654),

the assembly consists of a 6-inch PP screw closure with a 2-inch sanitary ferrule welded in the center, a 2-inch silicone gasket, and a true union fitting. Can be connected to other 2-inch sanitary fittings for drain lines and closed system filling. Individually packaged. Autoclavable, but must be kept vertical if assembled with lower assembly (Cat. No. 2654). Autoclavable.

Autoclavable Dolly—Stainless Steel

Designed to move small Saint-Gobain Performance Plastics tanks (up to 30 gallons/115 liters) during daily use or servicing. Do not use for tanks with spigots. Non-corrosive and chemically resistant to acids and bases. Casters won't leave marks on floor. Autoclavable.

Cat. No. 2624 -0020	
Maximum weight limits, lbs.;kg	500; 227.3
I.D. x H, in.; mm	20-1/2 x 6-1/2; 521 x 165

Sanitary Conical Process Vessels

Sanitary Conical Process Vessels

Sanitary Conical-Bottom Process Systems

Specially designed for use in the bio-pharmaceutical market, but suitable for any application where aseptic, sanitary, non-metallic fluid handling is desired. Each tank is manufactured from resins that meet USP Class VI and non-cytotoxic standards and are suitable for use in food and beverage applications. Tanks are available in autoclavable polypropylene (PP) and chemical-resistant polyvinylidene fluoride (PVDF).

Sanitary ferrules installed to customer specifications. Pre-engineered stands.

Sanitary Conical-Bottom Process Vessels—Polypropylene

- Our polypropylene resin is autoclavable
- Excellent with dilute and strong acids and bases
- Non-cytotoxic standards
- Autoclavable

- USP Class VI
- Silicone gasket and phenolic knobs included
- Fittings and accessories sold separately (see following pages)

Sanitary Conical-Bottom Process Vessels—Polyvinylidene Fluoride (PVDF)

- PVDF resin is extremely pure
- Excellent chemical resistance
- Non-cytotoxic standards
- Fittings sold separately
- Graduated
- PVDF is not autoclavable
- Call to discuss other methods of sterilization



POLYPROPYLENE

Cat. No. 2690	-0030	-0050	-0100	-0200	-0500	-0800	-1400
Nominal Capacity, liter	30	50	100	200	500	800	1400
Brim Capacity, liter	33	55	110	220	550	880	1540
O.D. x Height, with Cover, cm	44.5 x 49.3	55.6 x 49.8	55.6 x 83.6	66.3 x 105.7	91.4 x 131.3	117.6 x 124.5	152.4 x 123.4
O.D. x Height, with Cover, in.	17.5 x 19.6	22 x 19.6	22 x 33	26 x 41.6	36 x 51.7	46.3 x 49	60 x 48.6
Weight, lb.	25	30	35	80	115	157	196

POLYVINYLIDENE FLUORIDE (PVDF)

Cat. No. 2691	-0030	-0050	-0100	-0200	-0500	-0800
Nominal Capacity, liter	30	50	100	200	500	800
Brim Capacity, liter	36	62	115	230	550	880
O.D. x Height, with Cover, cm	44.5 x 49.3	55.6 x 49.8	55.6 x 83.6	66.3 x 105.7	91.4 x 131.3	117.6 x 124.5
O.D. x Height, with Cover, in.	17-1/2 x 18	22 x 21	22 x 25-1/2	26 x 41	36 x 51.7	46.3 x 49
Weight, lb.	40	45	50	105	135	182

These part numbers represent a tank with a solid, bolted, gasketed cover.

Conical Tank Stands

Tank Stands



PORTABLE TANK STAND,
CAT. NO. 2710 W/2690

Portable Tank Stands

- Optimal mobility
- Rounded surfaces for easy cleaning
- Passivated
- Locking casters
- Convenient handgrip
- Casters may be removed

Industrial-Style Stand Option (not shown)

- Lower-cost alternative to the portable cart
- Flat, angled steel construction
- Same size and configuration as shown on page 9
- Options:
 - 304 or 316 stainless steel
 - Sanitary casters
 - Support ring
 - Handles
 - Mixer support

PORTABLE TANK STAND—304 Stainless Steel

Cat. No. 2710	-0030	-0050	-0100	-0200	-0500	-0800	-1400
Fits Tank Size	30 Liters	50 Liters	100 Liters	200 Liters	500 Liters	800 Liters	1400 Liters

PORTABLE TANK STAND—Powder-Coated Stainless Steel (White)

Cat. No. 2711	-0030	-0050	-0100	-0200
Fits Tank Size	30 Liters	50 Liters	100 Liters	200 Liters

Sanitary Tank Mixers

BioTech Mixing Systems

Pre-engineered, ready-to-use mixer packages, Saint-Gobain Performance Plastics BioTech mixer overhead drives and lower assemblies/shafts and impellers have been specially designed to deliver maximum mixing efficiency. Each component has been carefully chosen to match a specific Saint-Gobain Performance Plastics mixing vessel. Use them with the closed-dome bio tanks (Cat. No. 2650) and sanitary conical-bottom processing tanks (Cat. Nos. 2690/2691). Requires 2" sanitary connection (2661-0200) at 10°< (for conical units), 2" silicone gasket (2672-0200) and true union (2670-0200).

Saint-Gobain Performance Plastics vessel and mixer packages are designed for liquids and liquid slurries only. Saint-Gobain does not warrant them for any specific application, only general-purpose mixing up to these maximum limits:

- **Solids**—20% by weight
- **Specific Gravity** (batch)—1.2
- **Viscosity**—500 centipoise

BioTech Mixer Overhead Drives

Overhead drives are available in two power configurations—1/20 Horse Power and 1/8 Horse Power.

Both Drives Feature:

- Autoclavable in-place
- Variable speed controls for better accuracy
- Programmable timers for hands-off control
- LCD readouts for speed, power, torque, impeller flow and time
- Audible overload alarm

1/20 H.P. (Cat. No. 2653-0001)

- 75-liter closed-dome tanks
- 30- and 50-liter sanitary conical-bottom processing tanks

1/8 H.P. (Cat. No. 2653-0002)

- 30-, 50-, and 100 gallon closed-dome tanks

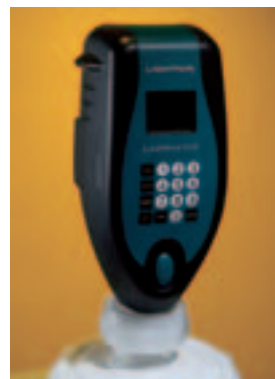

MIXER OVERHEAD DRIVE
CAT. NO. 2653

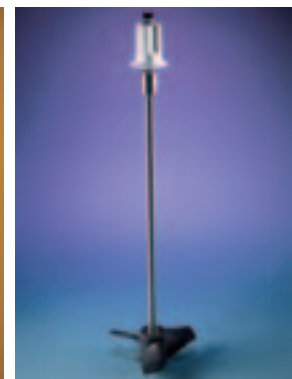

LOWER ASSEMBLY/SHAFT
CAT. NO. 2654

- 100-liter sanitary conical-bottom processing tanks
- 200-liter sanitary conical-bottom processing tanks
- Can be used interchangeably with all sanitary units under 200L.

Lower Assemblies/Shfts and Impellers

- For use with overhead drive
- 316 stainless steel shaft
- 316 stainless steel axial-flow impellers
- Autoclavable
- Encapsulated assemblies available—non-metallic wetted surfaces
- Attaches to 2" connection with true union and gasket

Cat. No. 2653	-0001	-0002
Electrical requirements	115V/60 Hz/1 PH	115V/60 Hz/1 PH
Power (W)	40	115
RPM	20-250	20-140
HP	1/20	1/8

Lower module allows for use with 110/220 v, 50/60 Hz and accepts a universally available power cord.

NOTE: Lower assemblies/shafts and impellers and mixer support (required for closed-dome tanks only) are necessary to complete each system and are sold separately (see Cat. Nos. 2654 and 2651).

LOWER ASSEMBLIES/SHAFTS AND IMPELLERS

Cat. No.	For Use With	Overhead* Drive Cat. No.	Shaft Length (in., mm)	Shaft Diameter (in., mm)	Impeller Diameter (in., mm)	Impeller Material
2654-0030†	30-gallon closed-dome bio tank (2650-0030)	2653-0002	30; 762	1/2; 13	6.8; 173	Stainless Steel
2654-0031	30- and 50-L sanitary conical tanks (2690/2691-0030, -0050)	2653-0001	17; 432	1/2; 13	6.1; 155	Stainless Steel
2654-0055†	55-gallon closed-dome bio tank (2650-0055)	2653-0002	32; 813	1/2; 13	8.8; 224	Stainless Steel
2654-0075†	75-L closed-dome tank (2650-0020)	2653-0001	23; 584	1/2; 13	6.3; 160	Stainless Steel
2654-0101	100-L sanitary conical tank (2690/2691-0100)	2653-0002	28; 711	1/2; 13	6.1; 155	Stainless Steel
2654-0100†	100-gallon closed-dome bio tank (2650-0100)	2653-0002	38; 965	1/2; 13	10; 254	Stainless Steel
2654-0201	200-L sanitary conical tank (2690/2691-0200)	2653-0002	36; 914	1/2; 13	8.8; 225	Stainless Steel

* The 2653-0002 is appropriate for use with all tanks. †Requires mixer support (2651-0200).

Sanitary Drain Options

Drain Option Products



POLYPROPYLENE VALVE BODY WITH SILICONE, CAT. NO. 2695

Sanitary Conical Drain Valve— Polypropylene Valve Body With Silicone Diaphragm

- Manually activated
- Allows for complete drainage
- Assures complete mixing
- Eliminates “dead leg”
- Stainless steel spacer ring
- Stainless steel actuator
- Glass-filled acetal locking ring
- Factory installed only



DIAPHRAGM VALVE, CAT. NO. 2674

Diaphragm Valve— Polypropylene

- USDA, food-grade polypropylene housing
- Perfluoroalkoxy (PFA) interior diaphragm
- Multi-position handle to precisely vary the flow rate
- Flush time approximate 6 seconds
- Not autoclavable



POLYPROPYLENE BALL VALVE, CAT. NO. 2673

Ball Valve— Polypropylene

- USDA, food-grade polypropylene ball
- 1/4-turn opening and closing
- Sanitary flanges
- Flush time approximate 45 seconds
- Autoclavable when handle is removed

CONICAL DRAIN VALVE—Polypropylene

Cat. No. 2695	-1501	-2001	-2101
Size, mm; in.	38; 1-1/2	51; 2	51; 2*

* Fits 1400-L sanitary conical-bottom tanks only.

CONICAL DRAIN VALVE—PVDF

Cat. No. 2697	-1501	-2001
Size, mm; in.	38; 1-1/2	51; 2

REPLACEMENT DIAPHRAGMS

Cat. No. 2696	-1501	-2001
Size, mm; in.	38; 1-1/2	51; 2
Diaphragm Material	Silicone	Silicone

DIAPHRAGM VALVE—Polypropylene

Cat. No. 2674	-0150**
Size, mm; in.	38; 1-1/2

BALL VALVE—Polypropylene

Cat. No. 2673	-0150**
Size, mm; in.	38; 1-1/2 tri

** Other sizes available

Sanitary Fittings and Accessories

Sanitary Fittings/Accessories

The following accessories and factory-installed ferrules are available options for Saint-Gobain Performance Plastics sanitary tank products. Use them to modify the tank for your specific application. Specify fittings and placement location when ordering tank.

INSTALLED SANITARY FERRULES—HDPE

Cat. No. 2660	-0075	-0100	-0150	-0200	-0300	-0400	-0600
Size, mm; in.	19; 3/4 mini	25; 1 tri/ladish	38; 1-1/2 tri	51; 2 tri	76; 3 tri	102; 4 tri	152; 6 tri

INSTALLED SANITARY FERRULES—PP

Cat. No. 2661	-0075	-0100	-0150	-0200	-0300	-0400	-0600
Size, mm; in.	19; 3/4 mini	25; 1 tri/ladish	38; 1-1/2 tri	51; 2 tri	76; 3 tri	102; 4 tri	152; 6 tri

INSTALLED SANITARY FERRULES—PVDF

Cat. No. 2692	-0075	-0100	-0150	-0200	-0300	-0400
Size, mm; in.	19; 3/4 mini	25; 1 tri/ladish	38; 1-1/2 tri	51; 2 tri	76; 3 tri	102; 4 tri

4" and larger fittings may have placement restrictions. Contact customer service or technical department for assistance.

SANITARY GASKETS—Platinum-Cured Silicone

Cat. No. 2672	-0075	-0100	-0150	-0200	-0300	-0400	-0600
Size, mm; in.	19 3/4 mini	25 1 tri/ladish	38 1-1/2 tri	51 2 tri	76 3 tri	101 4 tri	152 6 tri

SANITARY GASKETS—Viton® Fluoroelastomer

Cat. No. 2671	-0075	-0100	-0150	-0200	-0300
Size, mm; in.	19; 3/4 mini	25; 1 tri/ladish	38; 1-1/2 tri	51; 2 tri	76; 3 tri

TRUE UNION CLAMPS—PVDF

Cat. No. 2670	-0075	-0150	-0200	-0300
Size, mm	19	38	51	76
Size, in.	3/4 mini	1-1/2 tri	2 tri	3 tri

Recommended for use with plastic fittings. Avoids over-tightening which can crack the fitting. Maintains concentric connections.

Installed Sanitary Ferrules— High-Density Polyethylene; Polypropylene; Polyvinylidene Fluoride

- Customize the vessels to your specific processing needs using the ferrules
- Accessories require 2" connections for installation

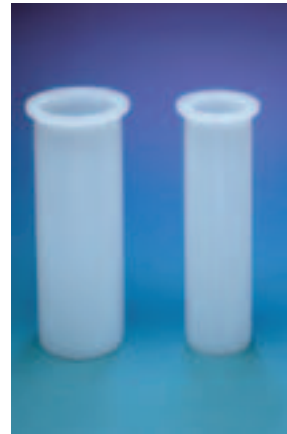

SANITARY FERRULES, CAT. NO. 2660

Sanitary Gaskets

Platinum-Cured Silicone

- Autoclavable



SANITARY GASKET, PLATINUM-CURED, CAT. NO. 2672

Viton® Fluoroelastomer

- Not autoclavable



SANITARY GASKET, VITON®, CAT. NO. 2671

True Union Clamps— PVDF

- For prevention of damage to plastic connection
- Autoclavable



TRUE UNION CLAMPS, CAT. NO. 2670

Sanitary Fittings and Accessories

Sanitary Fittings/Accessories



END AND SIGHT CAPS,
CAT. NOS. 2665 AND 2666

End Caps—

Polypropylene

- Autoclavable, seals ferrule when not in use

Sight Caps—

Polysulfone

- Autoclavable
- Allows visibility into vessel

END CAPS—Polypropylene

Cat. No. 2665	-0075	-0150	-0200	-0300	-0400	-0600
Size, mm	19	38	51	76	102	152
Size, in.	3/4 mini	1-1/2 tri	2 tri	3 tri	4 tri	6 tri

SIGHT CAPS—Polysulfone*

Cat. No. 2666	-0200-	0300
Size, mm; in.	51; 2 tri	76; 3 tri



ELBOW SWEEPS,
CAT. NO. 2663

Elbow Sweeps and Concentric Reducers—

Polypropylene

- Autoclavable

ELBOW SWEEPS—Polypropylene*

Cat. No.	2662-0150	2663-0150
Angle	90°	45°
Size, mm, in.	38, 1-1/2 tri	38, 1-1/2 tri

CONCENTRIC REDUCERS—Polypropylene*

Cat. No. 2669	-0001	-0002	-0004	-0005	-0006
Size, mm	19 x 38	25 x 38	51 x 38	51 x 25	51 x 76
Size, in.	3/4 mini x 1-1/2 tri	1 tri x 1-1/2 tri	2 tri x 1-1/2 tri	2 tri x 1 tri	2 tri x 3 tri



HEAVY DUTY CLAMP,
CAT. NO. 2685

Heavy Duty Clamps—

Stainless Steel

- Spring-loaded clamps to assure tight, leakproof fluid connections
- Autoclavable

HEAVY DUTY CLAMP—Stainless Steel

Cat. No. 2685	-0150	-0200	-0300	-0400	-0600
Size, mm; in.	38; 1-1/2	1; 2	76; 3	102; 4	152; 6

Not recommended for use with plastic fittings

*Other sizes available.

Sanitary Fittings and Accessories

Sanitary Fittings/Accessories

Siphon Tubes

For use on Saint-Gobain Performance Plastics closed-dome bio tanks (Cat. No. 2650) for easy fluid transfer using a peristaltic or vacuum pump. This 3/4-inch mini-siphon tube (5/8-inch I.D.) has a 2-inch sanitary mount and connects to mount on a 2-inch (50-mm) sanitary fitting. Tubes are cut to appropriate lengths for the 20-, 30-, 55- and 100-gallon (75-, 115-, 210- and 380-liter) tanks. Fittings must be installed on tank to use this product. Materials are non-cytotoxic, meet USP

Class VI and comply with 21 CFR 177.1520 for food and beverage use.* Autoclavable.

Sanitary Process Vessel Siphon Tubes—Polypropylene

For product sampling, reagent introduction and drainage. Removable siphon tube mounts to a 2-inch sanitary flange and extends into the bottom of cone. Rigid 3/4-inch (19-mm) mini-tube is compatible with common sanitary connectors including sanitary adapters, Sani-Lock, true-union clamps, short bull tees and gaskets.

Siphon tube does not interfere with lower assembly during mixing. Complies with 21 CFR 177.1520(c) 3.1 and USP Class VI regulations. Non-cytotoxic. Tubes are cut to length. Autoclavable.



SIPHON TUBE

SIPHON TUBE

Cat. No. 2656	-0030	-0055	-0100	-0200
Capacity, liter; gallons	75; 20	115; 30	208; 55	378; 100 Sanitary
Mount, mm; in.	51; 2	51; 2	51; 2	51; 2
Tube I.D., mm; in.	16; 5/8	16; 5/8	16; 5/8	16; 5/8
Tube O.D., mm; in.	25; 0.985	25; 0.985	25; 0.985	25; 0.985
Tube Length, cm; in.	92; 36-1/3	103; 40-1/2	115; 43-1/3	135; 53

SANITARY PROCESS VESSEL SIPHON TUBE

Cat. No. 2658	-0050	-0200
Capacity, liter; gallons	50; 13	200; 53
Mount, mm; in.	51; 2	51; 2
Tube I.D., mm; in.	14; 9/16	14; 9/16
Tube O.D., mm; in.	19; 3/4	19; 3/4
Tube Length, cm; in.	90; 35-1/4	97; 38
For use with sanitary connection	3/4-in. mini	3/4-in. mini

*Polypropylene meets all food grade requirements except for use with Food Type IV A (water-in-oil emulsions) and Food Type V (low-moisture fats and oils). The food type definitions are listed in 21 CFR 176.170(c).

Sanitary Fittings and Accessories

Sanitary Fittings/Accessories



ROTARY SPRAY JET,
CAT. NO. 2677-0001

Rotary Spray Jet Acetal With Stainless Steel Spray Inserts

For cleaning Closed-Dome Bio Tank and Sanitary Process Vessel interiors. Mounts and fits through a 2-inch sanitary flange; easily removable. Provides minimum of 300° spray pattern for complete cleaning. Must order Mounting Assembly (Cat. No. 2678-0001) separately. Autoclavable.

ROTARY SPRAY JET Acetal with Stainless Steel Spray Inserts

Cat. No. 2677	-0001
Pressure	20 to 30 psig.
Flow Rate	6 to 7 gal./min.



APPARATUS FOR SPRAY JET
NOZZLE, CAT. NO. 2678-0001

Mounting Apparatus for Spray Jet Nozzle Polysulfone

Mounting apparatus 2678-0001 permits use of Rotary Spray Jet (Cat. No. 2677-0001). Mounts to a 2-inch sanitary flange. Easily removable. Ends in a 3/4-inch mini flange. Cleans with tank/vessel lower assembly in place. Autoclavable.



1-INCH LADISH CHARGING
ELBOW, CAT. NO. 2681-0001

1-Inch Ladish Charging Elbow Polypropylene With 2-inch Sanitary Mount

When adding fluid, 2681-0001 elbow deflects flow to side of container wall, minimizing foaming. Prevents altering of buffer pH solutions and protein degradation. Autoclavable.



SANI-SAMPLING DEVICE,
CAT. NO. 2680-0001

Sani-Sampling Device Polypropylene With 2-inch Sanitary Mount

Catalog No. 2680-0001. Polypropylene sample tube extends into upper 1/4 of Closed-Dome Bio Tanks or Sanitary Process Vessels. Uses PTFE Syringe Filter and 3-way Luer-Lok** valve. Luer-Lok® connections allow easy connection to syringes and other micro tubing. Autoclavable.

Sani-Sampling Valve 3-Way, Polypropylene

Catalog No. 2683-0001. Three-way Luer-Lok® valve. Allows easy connection to PTFE syringe filters or Sani-Sampling Device (Cat. No. 2680-0001). Autoclavable.

Proper Placement and Autoclave Instructions

Fabrication Guide for Sanitary Conicals (2690-Series)

1. How is tank being drained?

- (a) Sanitary drain valve (2695-XXXX)
- (b) Diaphragm valve (2674-0150)
- (c) Ball valve (2673-0150)

If (a), what size?

If (b) or (c), it needs a 1.5" sanitary ferrule in the cone (2661-0150).
Other sizes are available custom.

2. Is a spray jet or other cleaning system being used?

If yes, and it's our system, a spray jet (2677-0001), mounting apparatus (2678-0001), 2" ferrule (2661-0200), 2" silicone gasket (2672-0200), and 2" true union (2670-0200) are needed. For 200L and smaller units, 1 spray jet with 2" center mount is sufficient. 500 and 800L require (2) and 1400L requires (3) equally spaced jets.

3. Is a mixer being used?

If 200L or smaller, use the mixer recommended in the catalog. Our mixer requires a 2" ferrule (2661-0200), 2" silicone gasket (2672-0200), and 2" true union (2670-0200). The ferrule is installed at a 10° angle and has standard placement. For mixers 500L or larger, you may contact us or a LIGHTNIN representative.

4. Are any accessories being used?

If yes, all our accessories require a 2" ferrule (2661-0200), 2" silicone gasket (2672-0200), and 2" true union (2670-0200), plus the part number of the accessory. Specify placement when ordering.

5. Are other ports required?

Use appropriate size ferrule. Specify placement. A vent is needed if inlets/outlets are specified.

6. Are end caps required?

These are not installed on the tank at time of shipment unless requested. End caps need a gasket and true union of the same size.

7. What type of stand is needed?

Portable carts are available for all sizes of Sanitary Process Vessels. Mixers for the larger vessels are too heavy to be supported by the tank alone. Our "industrial" stands are available in S/S as an alternative to the carts and are available with mixer support.

Information on Autoclaving Polypropylene Products

Autoclaving represents one of the most severe application conditions to which Saint-Gobain Performance Plastics High-Performance Tanks may be subjected. During the autoclaving cycle, products are typically maintained at 15 psig, while at temperature very near the plastics' heat deflection temperature. Under these conditions, any force, weight or pressure bearing on the product can contribute to deformation or collapse. Plastic vessels and containers cannot be sealed when autoclaving. For best results, products should be free standing and loosely covered, or with their closures resting on top with threads disengaged. During the decompression phase of the autoclaving cycle, the pressure within the vessel must be allowed to equalize. Any material placed over the opening may cause a vacuum to form, resulting in implosion or collapse.

The recommended autoclaving cycle is 121°C, 15 psig for 20 minutes.

The following practices should be AVOIDED when autoclaving plastic products:

- Stacking of jars, vessels, and carboys
- Placing the product in an autoclaving basket with other objects on top
- Tightening of closure prior to cooling
- **Securing any of the following over the opening:**
 - Aluminum foil
 - Gauze
 - Tape
 - Blue Steriwrap
 - Cotton

NOTE: Customers often report improved performance by autoclaving new products **completely uncovered** the first time. This practice may condition the product, relieving any residual stresses from the molding process and rendering it more resistant to subsequent autoclaving.

Putting It All Together

Sanitary Process Vessel
pages 19-21

Fittings



Accessories

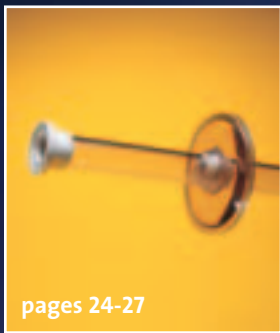

Sanitary Mixers



Portable Conical-Bottom Tank Stand
Sanitary stands,
page 21

Drain Valve



General Guide to Bulk Storage Tanks

A Complete Line of Rotationally Molded Bulk Storage Tanks

Saint-Gobain Performance Plastics bulk storage tanks, designed for a variety of indoor and outdoor uses, are available in many sizes and shapes. They're rotationally molded of rugged cross-linked high-density polyethylene (XLPE) and high-density polyethylene (HDPE), which is a linear polyethylene. Rotomolding reduces molded-in stresses, making the tanks durable and resistant to stress-cracking chemicals. This process also assures seamless, lightweight, uniform construction.

High Performance Resins

XLPE tanks are ideal for storing a wide range of corrosives, inorganic and organic chemicals and compounds, and boiler treatment chemicals. HDPE tanks can safely store foodstuffs (resin complies with 21 CFR Regulation 177.1520. Refer to footnote 4 on page 2), as well as many inorganic acids.

Plastics are Tough to Beat

Saint-Gobain bulk storage tanks offer distinct advantages over steel/fiberglass products. They are lighter in weight, more corrosion-resistant, translucent and easier to maintain than steel tanks. Seamless construction eliminates leakage problems often associated with fabricated tanks. Unlike fiberglass, plastic tanks do not wick. Saint-Gobain tanks are usually less expensive than either stainless steel or fiberglass.

There's definitely a Saint-Gobain bulk storage tank to suit your requirements. Choose from vertical, conical-bottom or horizontal configurations. They come with a variety of accessories, too, including insulation, heat tracing, fill lines, and other items. A simple call to your Authorized Saint-Gobain Distributor is all it takes to order one of these tanks, known industry-wide for quality and reliability.



RESIN SELECTION GUIDE			
PROPERTIES	HIGH-DENSITY POLYETHYLENE (HDPE)		CROSS-LINKED HIGH-DENSITY POLYETHYLENE (XLPE)
Chemical Resistance (general)	Very Good		Very Good
Stress-Crack Resistance	Good		Excellent
Maximum Service Temperature	150°F / 65°C		150°F / 65°C
Brittleness Temperature	-94°F / -70°C		-180°F / -118°C
Impact Resistance	Good		Excellent
Abrasion Resistance	Good		Good
Rigidity	Good		Good
Cleanability	Very Good		Very Good
Weldability (hot gas)	Weldable		Not Weldable
Food-Grade Resin	Yes		No
Color	White (Natural)		Gray (Pigmented)
ADVANTAGES	<ul style="list-style-type: none"> • Rigid • Hard, Smooth Finish • Easy-To-Clean 		<ul style="list-style-type: none"> • Very Good Chemical Resistance • UV Stabilized for Outdoor Service
			<ul style="list-style-type: none"> • Excellent Impact Resistance • High Stress-Crack Resistance • Suitable for Many Corrosives Not Handled by FRP
			<ul style="list-style-type: none"> • UV Stabilized for Outdoor Service • Less Expensive Than Stainless Steel or Fiberglass
APPLICATIONS	<ul style="list-style-type: none"> • Storage of Organic and Inorganic Acids • Water Treatment 		<ul style="list-style-type: none"> • Dispensing of Laboratory and Photographic Chemicals • Storage of Wide Range of Corrosives
			<ul style="list-style-type: none"> • Storage of Organic and Inorganic Chemicals and Compounds • Metal Finishing/Plating • Chemical Processing
			<ul style="list-style-type: none"> • Storage of Boiler Treatment Chemicals • Water and Sewage Treatment • Bulk Chemical Storage • Storage of Caustics
NOT GENERALLY RECOMMENDED FOR	<ul style="list-style-type: none"> • Strong Oxidizing Agents, Aromatic Hydrocarbons, Liquefied Petroleum Gas, Solvents • Halogenated-Aliphatic Hydrocarbons 		<ul style="list-style-type: none"> • Strong Oxidizing Agents, Aromatic Hydrocarbons, Halogenated-Aliphatic Hydrocarbons, Liquefied Petroleum Gas, Solvents

Vertical Bulk Storage Tanks

Vertical Bulk Storage Tank Features

Saint-Gobain Performance Plastics vertical bulk storage tanks have a number of unique features.

The entire line offers:

- Sizes ranging from 550 gallons to 12,000 gallons
- Choice of two resins (XLPE, HDPE) and two specific gravities (1.5, 1.9) at 73°F
- Circular top head flat for fittings (excluding 550-gallon size)
- Several cover options
- FOB, Garrett, Indiana 46738
- Seamless construction
- Mounting flats on the bottom portion of the tank (up to 4,000 gallons)

- Tie-down lugs
- Translucent*; observable liquid level
- Molded-in graduations up to 4,000 gallons (90 inch diameter excluded)
- ASTM D 1998-96 (available at an additional cost)
- XLPE Tanks are gray, HDPE tanks are natural

Saint-Gobain Performance Plastics vertical storage tanks have flat bottoms for easy installation. Smaller tanks (550-1550 gallons) incorporate narrow-diameter design for space-saving bulk storage. This makes them economical for in-plant use.

Tanks are engineered for tough applications. They provide excellent low-temperature impact resistance and are UV stabilized for outdoor use.

On request, Saint-Gobain Performance Plastics will hydrostatically test your bulk storage tanks. Contact Saint-Gobain Performance Plastics for details.

Fittings and other accessories can be added as specified to meet your requirements. Options are found on pages 34 and 35.

NOTE: All dimensions noted on tank drawings are nominal. Vertical tanks do not include fittings, which must be ordered separately. Covers are included.

Tank Size (gallons)	Graduations (gallons)	D & H (in.)	Specific Gravity	MATERIAL		Wall Thickness (in.)	Approx. Weight (lbs.)	Standard Cover (in.)
				XLPE	HDPE			
				Cat. No. and Size Code	Cat. No. and Size Code			
550	50	48 x 84	1.5	N/A	N/A	N/A	N/A	N/A
			1.9	51309-0550	51109-0550	0.25	140	16
850	100	64 x 74	1.5	51305-0850	51105-0850	0.25	150	16
			1.9	51309-0850	51109-0850	0.28	170	16
1100	100	64 x 93	1.5	51305-1100	51105-1100	0.31	190	16
			1.9	51309-1100	51109-1100	0.37	220	16
1550	100	64 x 127	1.5	51305-1550	51105-1550	0.34	280	16
			1.9	51309-1550	51109-1550	0.41	415	16
2000	250	96 x 83	1.5	51305-2000	51105-2000	0.31	320	16
			1.9	51309-2000	51109-2000	0.44	445	16
2500	250	96 x 99	1.5	51305-2500	51105-2500	0.38	430	16
			1.9	51309-2500	51109-2500	0.50	625	16
3000	250	96 x 116	1.5	51305-3000	51105-3000	0.44	620	21
			1.9	51309-3000	51109-3000	0.56	800	21
3000 90-INCH DIAMETER	N/A	90 x 126	1.5	51305-3090	51105-3090	0.44	620	21
			1.9	51309-3090	51109-3090	0.56	800	21
4000	250	96 x 145	1.5	51305-4000	51105-4000	0.56	850	21
			1.9	51309-4000	51109-4000	0.81	1100	21
4000 90-INCH DIAMETER	N/A	90 x 162	1.5	51305-4090	51105-4090	0.56	850	21
			1.9	51309-4090	51109-4090	0.81	1100	21
5500	N/A	120 x 134	1.5	51305-5500	51105-5500	0.58	1100	21
			1.9	51309-5500	51109-5500	0.73	1600	21
6500	N/A	120 x 155	1.5	51305-6500	51105-6500	0.69	1400	21
			1.9	51309-6500	51109-6500	0.87	1900	21
8000	N/A	143 x 138	1.5	51305-8000	51105-8000	0.70	2200	21
			1.9	51309-8000	51109-8000	0.89	2800	21
10000	N/A	143 x 168	1.5	51305-9100	51105-9100	0.89	3000	21
			1.9	51309-9100	51109-9100	1.13	3400	21
12000	N/A	143 x 198	1.5	51305-9200	51105-9200	1.07	3800	21
			1.9	51309-9200	51109-9200	1.36	4400	21

*Observation of liquid level depends on favorable light conditions, liquid color and a clean tank wall. Natural resin must be used, however, Saint-Gobain can not guarantee translucency. If liquid level observation is critical a sight gauge is recommended.

**Wall thickness based on bottom side wall. N/A = Not Available

Insulation, Heat Tracing and Fill Lines Available

Insulation — Permanent factory-applied insulation is 2 inches thick and consists of 1.8 lbs-per-cubic-foot-density, non-

CFC containing urethane foam with a mastic coating.

Heat Tracing — Heater package consists of 115 Volt, dual-controlled thermostats enclosed in a fiberglass housing.

Securely mounted to tanks, heaters provide a 50°F Delta T or a 75°F Delta T.

Fill Lines — This pipe, fitting and bracket assembly allows you to fill storage tanks from an exterior inlet location.

Vertical Bulk Storage Tanks

Vertical Bulk Storage Tank Features

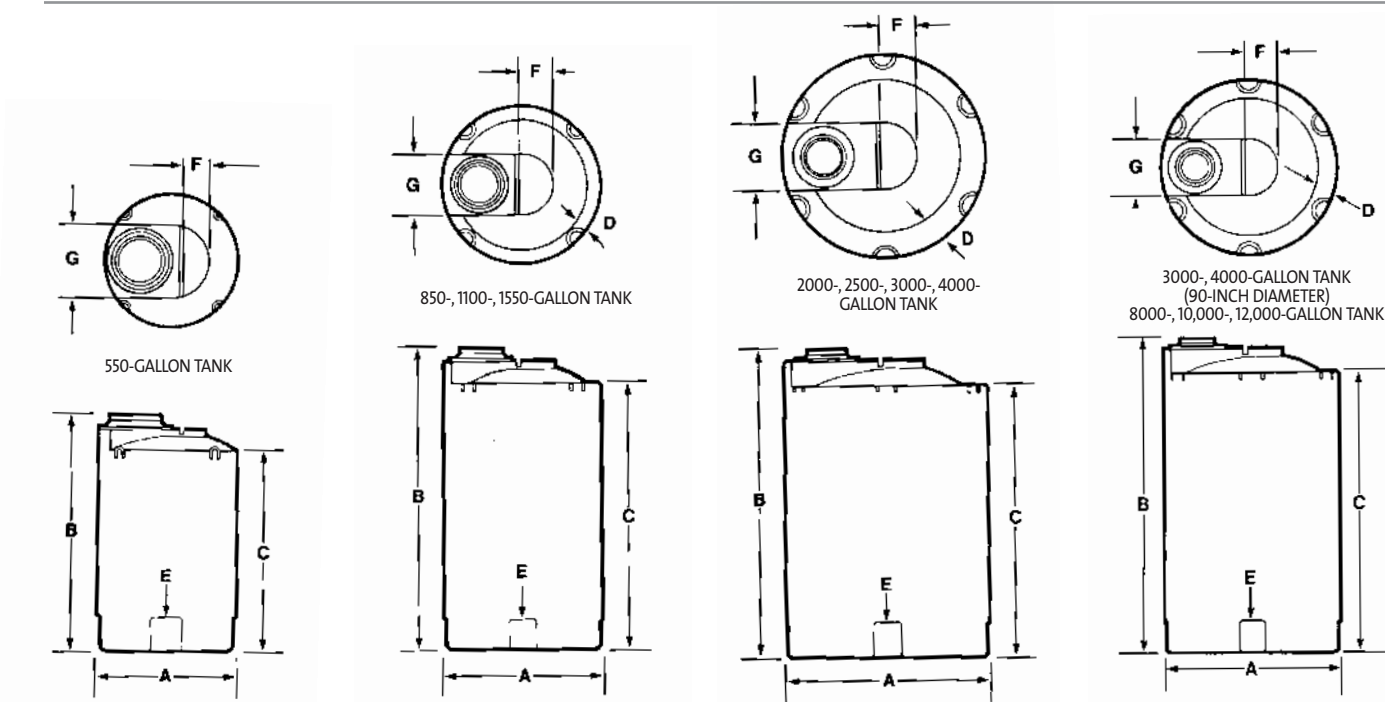

VERTICAL TANKS

Tank Size (gallons)	A	B	C	INCHES			
				D	E	F	G
550	48	84	72	N/A	11 x 12	9	26
850	64	74	62	6	11 x 12	16	26
1100	64	93	79	6	11 x 12	16	26
1550	64	127	113	6	11 x 12	16	26
2000	96	83	66	12	13 x 16	18	32
2500	96	99	82	12	13 x 16	18	32
3000	96	116	99	12	13 x 16	18	32
3000	90	126	109	9	7 x 9*	15	30
4000	96	145	128	12	13 x 16	18	32
4000	90	162	145	9	7 x 9*	15	30
5500	120	134	123	14	N/A	30-1/2	32
6500	120	155	144	14	N/A	30-1/2	32
8000	143	138	120	14	N/A	42	32
10000	143	168	150	14	N/A	42	32
12000	143	198	180	14	N/A	42	32

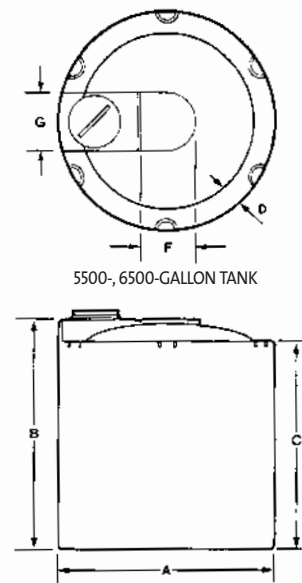

NOTE: When factory-installed fittings are required, you must provide us with the catalog number for each fitting, catalog number for each tank and drawings (freehand is acceptable) of each tank with its fitting(s).

*The minimum elevation for bottom outlet fittings is 9 inches (6 inches for 90-inch diameter tanks) up to 3 inch diameter fitting.

Conical-Bottom Bulk Storage Tanks

Conical-Bottom Bulk Storage Tank Features

Available in sizes from 1575 gallons to 8000 gallons, these tanks are durable, chemical-resistant and ideal for applications requiring complete drainage. All sizes are available in XLPE and HDPE. Tank features include:

- Seamless, one-piece construction — 1.9 specific gravity
- UV inhibitor for sunlight protection
- Observable liquid level (translucent)*
- Molded-in tie-down lugs (1575- and 2600-gallon sizes)
- Rugged steel stand with epoxy coating
- Molded-in graduations on 1575- and 2600-gallon only
- FOB, Garrett, Indiana 46738

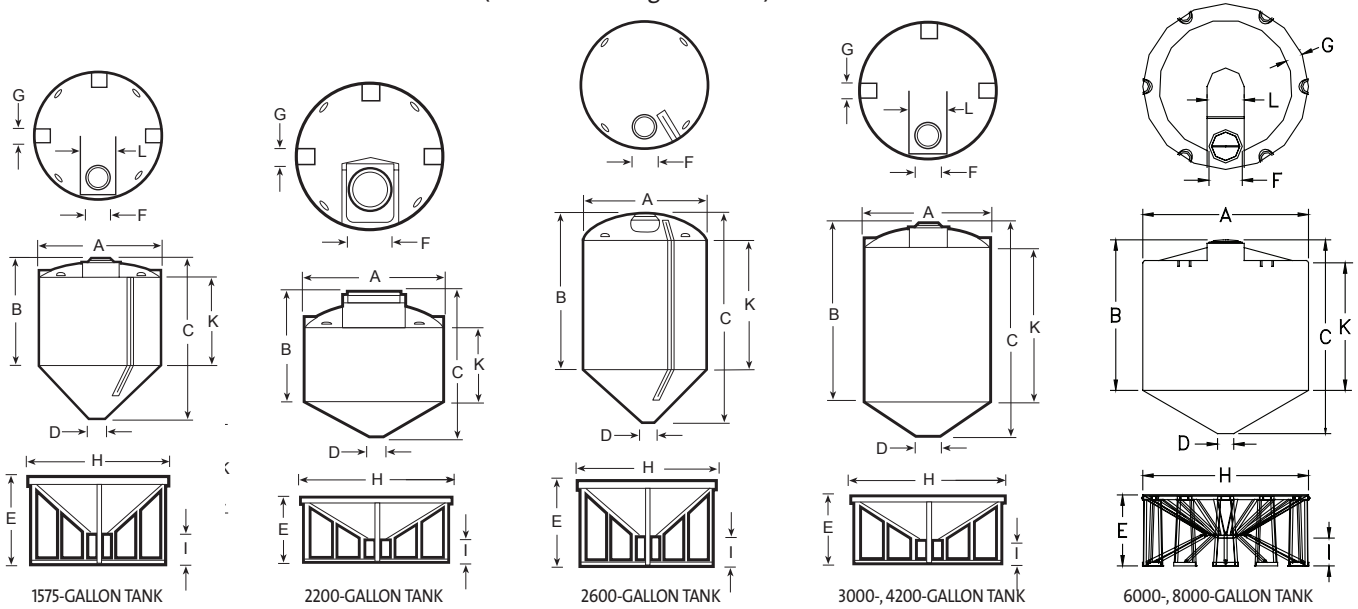

CONICAL-BOTTOM TANKS

Tank Size (gallons)	D&H (in.)	MATERIAL		Wall (in.)	Approx. Wt. (lbs.)	Grad. (gallons)	Stand Code	Approx. Wt. (lbs.)
		XLPE	HDPE					
1575	86 x 117	53309-1575	53109-1575	0.50	450	50	53009-1575	440
2200	96 x 119	53309-2200	53109-2200	0.56	600	N/A	53009-2200	440
2600	86 x 159	53309-2600	53109-2600	0.57	700	50	53009-2600	440
3000	90 x 154	53309-3000	53109-3000	0.56	825	N/A	53009-3000	450
4200	96 x 177	53309-4000	53109-4000	0.88	1100	N/A	53009-4000	550
6000	143 x 137	53309-6000	53109-6000	1.02	1900	N/A	53009-6000	3200
8000	143 x 167	53309-8000	53109-8000	1.29	2600	N/A	53009-8000	3200

NOTES: "H" dimension is total height of tank and stand. Tanks and stands must be ordered individually.

*Storage tanks with up to 0.75 inch wall thickness are translucent; however, observation of liquid level depends on favorable light conditions, liquid color and clean tank wall.
 **Wall thickness based on bottom side wall.

N/A = Not Available

CONICAL-BOTTOM TANKS AND EPOXY COATED STANDS

Tank Size (gallons)	INCHES											Cone Angle (degrees)
	A	B	C	D	E	F	G	H	I	K	L	
1575	86	60	103	9	57	16	10	86	14	45	28	45
2200	96	79	105	9	40	24	10	97	14	59	N/A	30
2600	86	102	145	9	57	16	N/A	86	14	84	N/A	45
3000	90	117	140	9	37	21	10	90	14	102	28	30
4200	96	137	163	9	39	21	10	96	14	122	28	30
6000	143	137	100	14	62	28	14	143	24	82	32	30
8000	143	167	130	14	62	28	14	143	24	112	32	30

NOTE: Maximum bottom outlet fittings is 3 inches.

Secondary Containment and Horizontal Leg Tanks

HDPE Secondary Containment Basins

Designed as durable barriers between storage tanks and the environment, these secondary containment basins feature:

- UV-stabilized black HDPE for outdoor use

- Tapered walls for easy nesting
- Rib and steel spreader bar divides 218 inch length into two equal sections (1750- and 3500-gallon basins only)

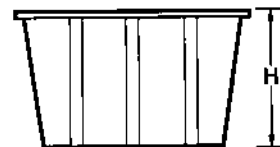

SIDE VIEW (SQUARE BASIN)

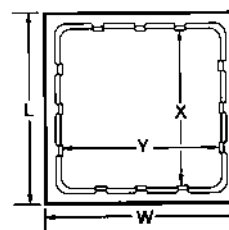

TOP VIEW (SQUARE BASIN)

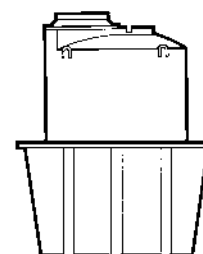

TYPICAL CONTAINMENT BASIN WITH TANK IN PLACE

HDPE SECONDARY CONTAINER BASINS

Capacity (gallons)	L x W x H (in.)	X Dimension (in.)	Y Dimension (in.)	Cat. No.	Size Code	Wall Thickness (in.)	Weight (lbs.)
375	66 x 66 x 24	59	59	59040	-0375	.220	100
495	69 x 69 x 28-1/2	62	62	59040	-0495	.250	125
950	83 x 83 x 45	69	69	59040	-0950	.375	320
1650	99 x 99 x 53	85	85	59040	-1650	.375	400
1750	218 x 108 x 21	94	203	59040	-1750	.500	580
3500	218 x 108 x 40	94	203	59040	-3500	.500	1020

NOTE: Basin walls are tapered; be sure to reference outside tank dimensions. Contact your local regulatory body for approval before selecting secondary containment basins because of varying requirements.

Saint-Gobain Performance Plastics Horizontal Leg Tanks

Cost-efficient design simplifies installation and saves money!

Saint-Gobain Performance Plastics horizontal tanks with molded legs conveniently mount on flat surfaces without any additional support. Eliminating FRP saddles and steel cradles allows easy installation and provides significant cost reduction. Most fittings are factory installed before shipping*.

- Economical (no saddles or cradles)
- Molded of translucent natural high-density polyethylene (HDPE) for applications with food-grade resin requirements (i.e. potable water)
- Molded of translucent gray UV-stabilized XLPE for outdoor chemical storage
- Sturdy, self-supporting construction
- Fittings available (See pages 34 and 35)
- Up to 1.5 specific gravity service
- Maximum operating temperature to 150°F/65°C
- FOB Garrett, Indiana 46738

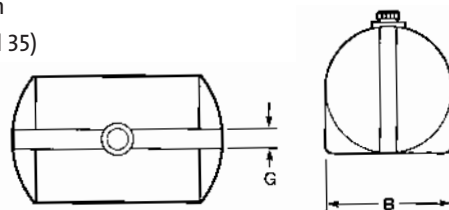
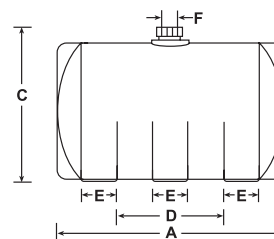

HORIZONTAL LEG TANKS

Tank Size (gallons)	Cat. No. HDPE	Cat. No. XLPE	Size Code	Specific Gravity	Wall Thickness (in.)	A	B	C	INCHES D	E	(TANK OPENING) F†	G	Approx. Wt. (lbs.)
55	25100	25300	-0055	1.5	5/16	33	25-1/4	29-3/4	20-1/2	4-1/2	6	7	40
110	25100	25300	-0110	1.5	5/16	46	29	33-1/2	21	7	6	7	60
200	25100	25300	-0200	1.5	5/16	57-1/2	35	39-1/2	30	9	6	7	80
300	25100	25300	-0300	1.5	5/16	67-1/2	40-3/4	45	35-1/2	10-1/2	6	7	110
500	25100	25300	-0500	1.5	5/16	76	46-1/2	49-1/2	39	12	6	7	150

*Saint-Gobain recommends all fittings be factory installed.
†Six-inch threaded closure.

Bulk Tank Fittings and Accessories

Tank Fittings

Fittings can be factory-installed or shipped loose for on-site installation. Fitting prices and installation charges, where required, must be added to the cost of the tank. When ordering, always supply drawings, and specify the type

of fitting required and exactly where it is to be installed. For open-top tank fittings and accessories, see pages 11-13.

Gaskets for Bulkhead Fittings





Fitting Resin	Gasket Material	No. of Gaskets
PP (Natural)	EPDM	1
PVC	EPDM	1
316 SS	EPDM	1
PVDF	VITON®	1

These two-part fittings screw or bolt together over a hole cut in the tank. Other gasket materials are available at added cost.

For Bulk Tanks

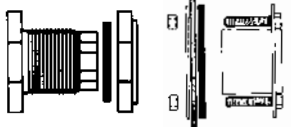
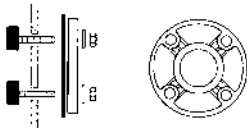
INSTALLED FITTINGS, MECHANICAL

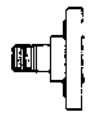
Size Code and Availability (X)

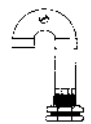
Fitting	Material	Cat. No.	-0025 (1/4")	-0050 (1/2")	-0075 (3/4")	-0100 (1")	-0150 (1-1/2")	-0200 (2")	-0300 (3")	-0400 (4")	-0600 (6")
 <p>Bulkhead Fittings (Plastic) (316 Stainless Steel)</p>	PVC	86301	—	X	X	X	X	X	X	X	—
	PP	86501	—	X	X	X	X	X	X	X	—
	316 SS	86650	—	—	—	X	X	X	X	X	—
PVC, SS and PP bulkhead fittings are supplied with one EPDM gasket. PVC and PP two-part fittings screw together over a hole cut in the tank. Other gasket materials are available at added cost. Fittings provide female pipe thread.											
 <p>Flanged Fittings* with Free Bolts (Encapsulated Heads)</p>	PVC threaded with EPDM Gasket and Encapsulated Bolt Heads with 316 SS Bolts	86200	—	X	X	X	X	X	X	X	X
	PVDF threaded with Viton®* Gasket and Bolt Heads with Hastelloy Bolts	86400	—	X	X	X	X	X	—	—	—
Optional titanium or Hastelloy bolts with Viton®* encapsulated heads available. *4-inch and 6-inch fittings are available only for tanks with 96-inch diameter or larger.											
 <p>Self-Aligning Bulkhead Fitting Install on Top-Dome Only</p>	PVC Body with Teflon®* Sealing Ring	86302	—	—	—	X	—	X	X	—	—
 <p>Flange Adapter with Nipple</p>	PVC	86320	—	—	—	—	X	X	X	X	—
 <p>Siphon Tube without Bulkhead Fitting</p>	PVC	86900	—	—	—	—	—	X	X	—	—
	316 SS	86651	—	—	—	—	—	X	X	—	—
	PP	86626	—	—	—	—	—	X	X	—	—
 <p>U-Vent with Bulkhead Fitting</p>	PVC	86304	—	—	—	—	—	X	X	X	—

*Viton and TEFLON are registered trademarks of E.I. DuPont de Nemours and Company Inc.

Bulk Tank Fittings and Accessories



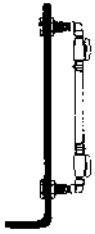

For Bulk Tanks

INSTALLED FITTINGS, MECHANICAL (continued)

Size Code and Availability (X)

Fitting	Material	Cat. No.	-0025 (1/4")	-0050 (1/2")	-0075 (3/4")	-0100 (1")	-0150 (1-1/2")	-0200 (2")	-0300 (3")	-0400 (4")	-0600 (6")
 <p>Sight-Gauge Assembly for Bulk Storage Tanks Only</p>	PVC	76000-0002	—	—	X	—	—	—	—	—	—
	<p>Consists of two PVC ball valves, fittings and clear PVC tubing (1-inch I.D.) installed close to top and bottom of tank unless otherwise specified. Contact Saint-Gobain Performance Plastics for single or triple valve design.</p>										

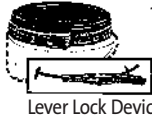
INSTALLED FITTINGS, MECHANICAL

 <p>Gaskets for PP and PVC Bulkhead Fittings*</p> <p>For Stainless Steel Bulkhead Fittings*</p>	EPDM	86780	—	X	X	X	X	X	X	X	—
	VITON®	86890	—	X	X	X	X	X	X	X	—
	EPDM	86781	—	X	—	X	X	X	X	X	—
	VITON®	86891	—	X	—	X	X	X	X	X	—
<p>Consists of PVC valves, fittings and translucent PE tubing (5/8 inch I.D. x 3/4 inch O.D.). Specify tubing length.</p>											
 <p>True Union Ball Valves, Threaded with One Nipple</p>	PVC	86303	—	X	X	X	X	X	—	—	—
<p>Female pipe threads with nipple on one end. These valves must be supported.</p>											
 <p>16-inch Cover Lever Lock Device</p>	HDPE	59000-0016	<p>For 550-, 850-, 1100-, 1550-, 2000- and 2500-gallon verticals and 1575- and 2600-gallon conical-bottom tanks.</p>								
 <p>21-inch Threaded with Cover</p>	HDPE	59000-0021	<p>Optional For 550-, 850-, 1100-, 1550-, 2000- and 2500-gallon verticals. Replacement for 3000- to 6,500-gallon vertical and 3000- and 4200-gallon conical-bottom tanks.</p> <p>Bolted and gasketed manway cover available — contact Saint-Gobain Performance Plastics</p>								

NOTE: Installation instructions for bulkhead fittings are available by contacting Saint-Gobain Performance Plastics.

Bulkhead Fitting Installation

Tank Diameter Minimums

Bulkhead Size (inches)	Min. Tank I.D. (inches)
1/2	7.25
3/4	10.00
1	11.75
1-1/4	16.25
1-1/2	16.25
2	25.75
3	42.50
4	90.00

For information on open-top tank fittings and accessories, see pages 11-13.

Blowers for Lab and Industrial Use

Reliable, All-Plastic Corrosion-Resistant Units



LAB-STYLE BLOWER

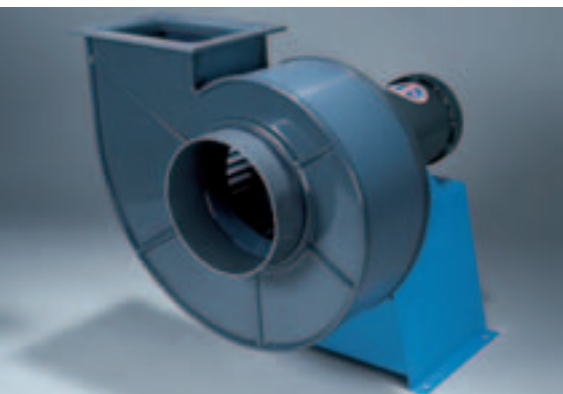

DIRECT DRIVE UNIT



BELT DRIVE UNIT

Saint-Gobain Performance Plastics' Norton® Blowers are excellent choices for aggressive applications where metal blowers quickly corrode. Metal blowers rely on protective coatings, which develop pin holes and pores. Corrosive vapors seep through and attack the metal, causing failure. Plastic blowers last much longer because the material is inherently resistant to corrosion.

The smaller laboratory units have round inlets and outlets. They are designed for use in lab hoods and cabinets. They are available in direct drive with 2 motor options and 2 wheel options.

The industrial units have round inlets and square outlets and offer much greater capacity.

They are proven performers in tough industrial applications, such as metal finishing, chemical manufacturing, wastewater treatment, and chemical storage cabinets. In addition to the options for drives, motors, and wheels, a full line of transitions and flexible connectors is available for connection to ductwork.

Norton blowers are ordered by selecting the right capacity, type of drive, motor and combination of plastic materials for your application. The "Four Steps to Blower Selection" on the following pages will guide you.

Blower Features

- Corrosion resistant
- Outlasts metal
- Quiet operation
- Choice of motors/materials
- Reinforced housing
- For indoor and outdoor[†] use
- Plastic transitions for easy attachment to standard ducting
- Full line of replacement parts

If installing your own motor, note that Norton blowers must not exceed the stated RPM of each blower (pages 40-42).

Industrial blowers feature round inlets and rectangular outlets. (For plastic transitions, see page 44)

NOTE: Blowers are supplied fully assembled in counterclockwise upblast position. Other counterclockwise positions are available on request.*

†Protect motors and drives against weather when blowers are roof-mounted. All outdoor vertical blower discharge ducts must have weather hoods.

**Except Cat. No. 71300 Series Lab Blower—no bottom horizontal or down-blast positions.*

Blower Performance Curves

Performance Curves for Belt-Drive Blowers

Saint-Gobain Performance Plastics belt-drive blowers are supplied with a 1:1 speed ratio. If you intend to change your blower's speed/capacity after installation, see the instructions supplied with all Saint-Gobain Performance Plastics belt-drive blowers.

- Solid black lines show performance of 1:1 belt-drive blowers.
- - - Broken black lines show belt-drive blower performance when speed-reducing sheaves are installed by customer.
- Color shows area of most efficient blower operation.

Size Code -0160

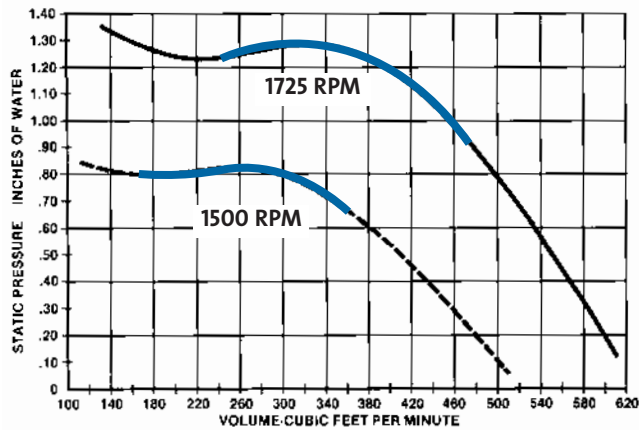

Size Code -0250

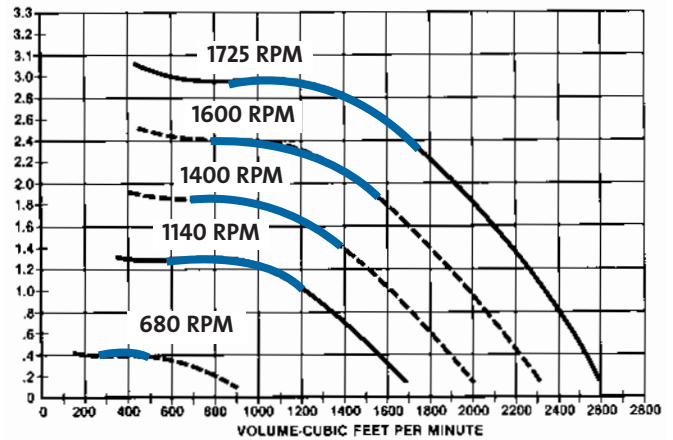

Size Code -0200

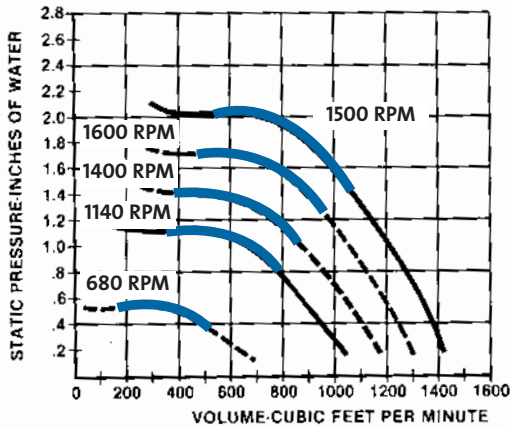

Size Code -0310

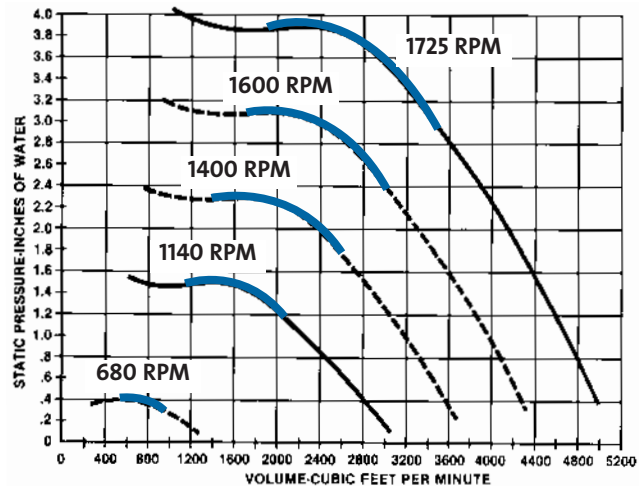

Size Code -0400

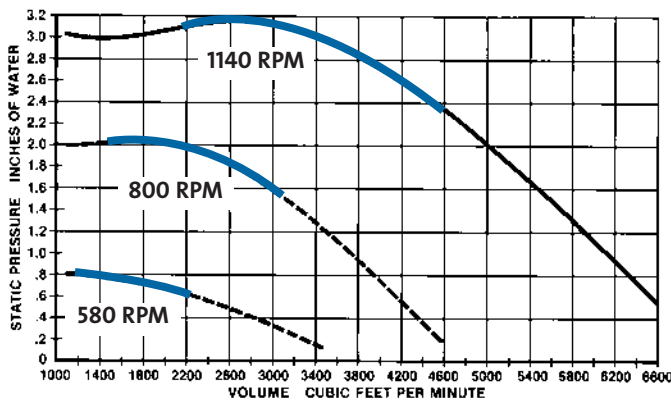

NOTE: Saint-Gobain Performance Plastics blowers must not exceed 1725 rpm (1140 rpm on Size Code -0400)

Blower Performance Curves

Lab Blowers

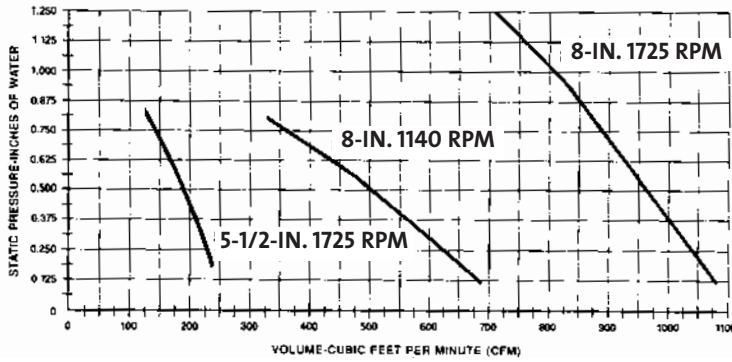

Industrial Blowers

Size Code -0160

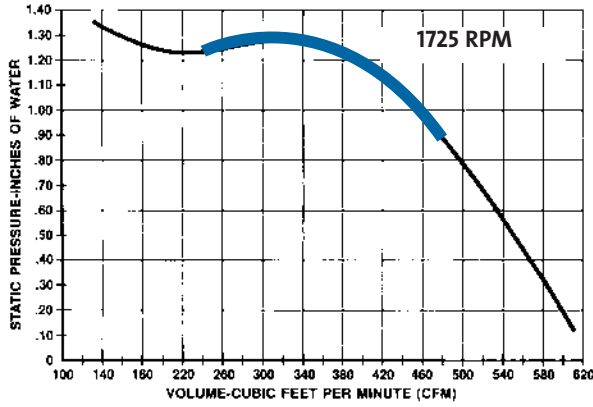

Size Code -0200

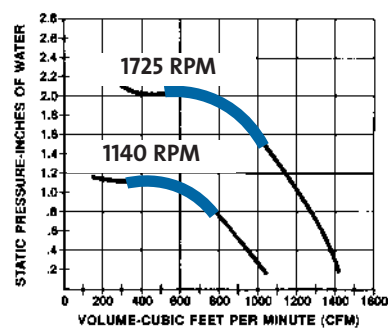

Size Code -0250

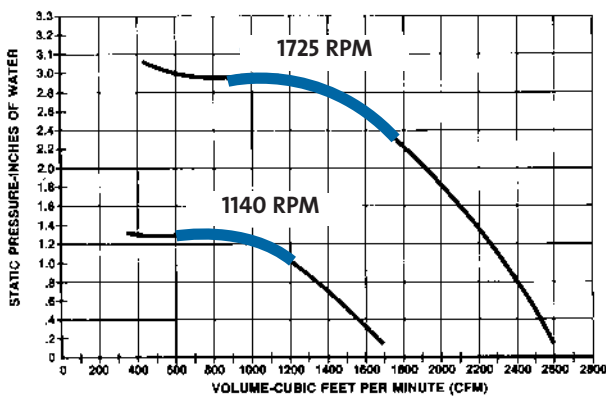

Size Code -0310

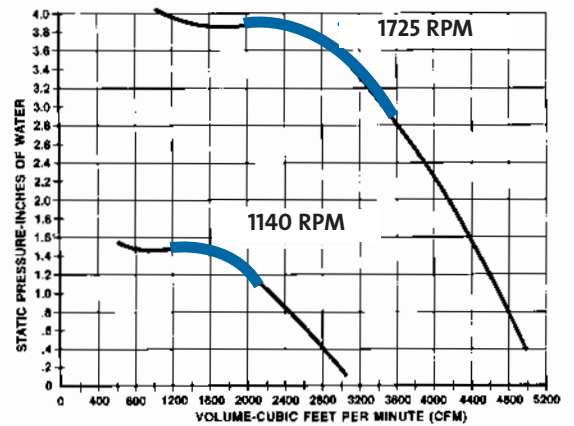

Size Code -0400

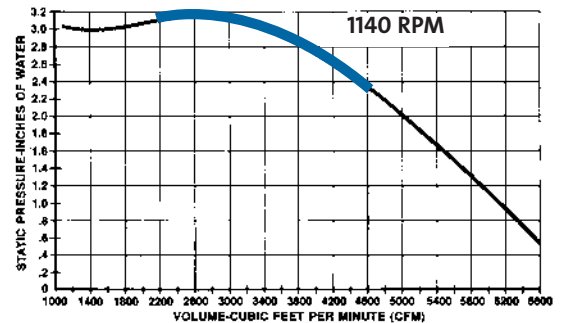

- Solid black lines show performance of 1:1 belt-drive blowers.
- Color shows area of most efficient blower operation.

Four Steps to Blower Selection

1. Determine Air Flow and Static Pressure

Air Flow is measured in CFM, or Cubic Feet per Minute, and represents the volume of the area to be ventilated in one minute.

Static Pressure is measured in inches of water. It is the total resistance to incoming air flow from ducts, fittings, elbows, dampers, and other factors.

You can determine your existing unit's capacity by checking the size and performance specs. For new installations, the CFM and Static Pressure should be determined by a mechanical engineer, HVAC contractor, ductwork manufacturer or other professional.

All our blowers are 60Hz.

2. Select Direct or Belt Drive (if needed)

Some size blowers are only available in direct drive. Others can be belt driven as an option. Consult page 35 for availability.

Direct Drive	Belt Drive
More compact	Field adjustable to vary capacity
Single speed	Flexible to process changes
Fewer moving parts	Reduces stress on motor bearings
No field adjustment	Economical in changing environments

3. Motor Selection

Motor Type	Features	Applications
Totally Enclosed Fan-Cooled (TEFC)	Housings have no direct openings Internal fan cools motor Insulated	Corrosive vapors Dirty, damp or oily service
Explosion Proof (XP)	UL-approved motor* Insulated	Forward curve blades

* UL and CSA for Class I, Group D or Class II, Group F and G.

4. Material Selection of Wheel

The wheel's chemical resistance takes priority because it is under centrifugal stress.

PVC	Polypropylene
Good chemical resistance	Very good general chemical resistance
Best at room temperature	Withstands higher temperatures, stresses
Low cost	Potentially explosive fumes or dust

GENERAL NOTES: Lab Blowers (size codes -0050 to -0150) have round inlets and outlets. Industrial blowers have round inlets and rectangular outlets (see dimension charts). All blowers used outdoors must be protected against weather. Blowers are supplied in counter-clockwise up-blast position. Other positions may be requested.

Blower Specifications

Lab Blower Specifications These charts are arranged by increasing CFM. All lab blowers are 60Hz.

See the preceding "Four Steps To Blower Selection."

140 to 225 CFM — 3/4 to 1/4 inch Static Pressure

SIZE CODES -0050/0075

Drive	Motor Enclosure	Material Wheel/Housing	Replacement* Parts	RPM	HP	Power Voltage (Phase)	Approx. Shipping (wt., lbs.)	Cat. No. and Size Codes
Dir.	XP	PP/PVC	1	1725	1/6	115 (1)	51†	71320-0075
Dir.	TEFC	PP/PVC	1	1725	1/6	115/208-230 (1)	31†	71330-0050

360 to 625 CFM — 3/4 to 1/4 inch Static Pressure

SIZE CODES -0050/0075

Drive	Motor Enclosure	Material Wheel/Housing	Replacement* Parts	RPM	HP	Power Voltage (Phase)	Approx. Shipping (wt., lbs.)	Cat. No. and Size Codes
Dir.	XP	PP/FRP	2	1140	1/3	115/230 (1)	60†	71420-0075
Dir.	TEFC	PP/FRP	2	1140	1/3	115/208-230 (1)	60†	71430-0050
Dir.	XP	PVC/FRP	4	1140	1/3	115/230 (1)	60†	71520-0075
Dir.	TEFC	PVC/FRP	3	1140	1/3	115/208-230 (1)	60†	71530-0050

710 to 1,025 CFM — 1-1/4 to 1/4 inch Static Pressure

SIZE CODES -0100/0150

Drive	Motor Enclosure	Material Wheel/Housing	Replacement* Parts	RPM	HP	Power Voltage (Phase)	Approx. Shipping (wt., lbs.)	Cat. No. and Size Codes
Dir.	XP	PP/FRP	2	1725	1/3	115/230 (1)	60†	71420-0150
Dir.	TEFC	PP/FRP	2	1725	1/3	115/208-230 (1)	60†	71430-0100
Dir.	XP	PVC/FRP	3	1725	1/3	115/230 (1)	60†	71520-0150
Dir.	TEFC	PVC/FRP	3	1725	1/3	115/208-230 (1)	60†	71530-0100

Industrial Blower Specifications These charts are arranged by increasing CFM. All lab blowers are 60Hz.

All industrial blowers have round inlets and rectangular outlets. See dimension charts later in this section for details. Plastic transitions are available to connect blowers to ductwork; refer to the last page in this section.

355 to 500 CFM — 1-1/4 to 3/4 inch Static Pressure

SIZE CODES -0160

Drive	Motor Enclosure	Material Wheel/Housing	Replacement* Parts	RPM	HP	Power Voltage (Phase)	Approx. Shipping (wt., lbs.)	Cat. No. and Size Codes
Dir.	XP	PP/PVC	5	1725	1/3	208-230/460 (3)	58	72521-0160
Dir.	TEFC	PP/PVC	5	1725	1/3	208-230/460 (3)	60	72531-0160
Dir.	XP	PVC/PVC	6	1725	1/3	208-230/460 (3)	58	72621-0160
Dir.	TEFC	PVC/PVC	6	1725	1/3	208-230/460 (3)	60	72631-0160
Belt	XP	PP/PVC	5	1725	1/3	208-230/460 (3)	135	72721-0160
Belt	TEFC	PP/PVC	5	1725	1/3	208-230/460 (3)	130	72731-0160
Belt	XP	PVC/PVC	6	1725	1/3	208-230/460 (3)	137	72821-0160
Belt	TEFC	PVC/PVC	6	1725	1/3	208-230/460 (3)	132	72831-0160

Blower Specifications

Industrial Blower Specifications These charts are arranged by increasing CFM. All blowers are 60Hz.

650 to 800 CFM — 1 to 3/4 inch Static Pressure

SIZE CODES -0200

Drive	Motor Enclosure	Material Wheel/Housing	Replacement* Parts	RPM	HP	Power Voltage (Phase)	Approx. Shipping (wt., lbs.)	Cat. No. and Size Codes
Dir.	XP	PP/PVC	7	1140	3/4	208-230/460 (3)	125	72520-0200
Dir.	TEFC	PP/PVC	7	1140	3/4	208-230/460 (3)	113	72530-0200
Dir.	XP	PVC/PVC	8	1140	3/4	208-230/460 (3)	128	72620-0200
Dir.	TEFC	PVC/PVC	8	1140	3/4	208-230/460 (3)	116	72630-0200

730 to 1,100 CFM — 2 to 1-1/4 inch Static Pressure

SIZE CODES -0200

Drive	Motor Enclosure	Material Wheel/Housing	Replacement* Parts	RPM	HP	Power Voltage (Phase)	Approx. Shipping (wt., lbs.)	Cat. No. and Size Codes
Dir.	XP	PP/PVC	7	1725	3/4	208-230/460 (3)	128	72521-0200
Dir.	TEFC	PP/PVC	7	1725	3/4	208-230/460 (3)	122	72531-0200
Dir.	XP	PVC/PVC	8	1725	3/4	208-230/460 (3)	116	72621-0200
Dir.	TEFC	PVC/PVC	8	1725	3/4	208-230/460 (3)	116	72631-0200
Belt	XP	PP/PVC	7	1725	3/4	208-230/460 (3)	138	72721-0200
Belt	TEFC	PP/PVC	7	1725	3/4	208-230/460 (3)	138	72731-0200
Belt	XP	PVC/PVC	8	1725	3/4	208-230/460 (3)	140	72821-0200
Belt	TEFC	PVC/PVC	8	1725	3/4	208-230/460 (3)	150	72831-0200

960 to 1,210 CFM — 1-1/4 to 1 inch Static Pressure

SIZE CODES -0250

Drive	Motor Enclosure	Material Wheel/Housing	Replacement* Parts	RPM	HP	Power Voltage (Phase)	Approx. Shipping (wt., lbs.)	Cat. No. and Size Codes
Dir.	XP	PP/PVC	9	1140	1	230-460 (3)	135	72520-0250
Dir.	TEFC	PP/PVC	9	1140	1	208-230/460 (3)	122	72530-0250
Dir.	XP	PVC/PVC	10	1140	1	230-460 (3)	138	72620-0250
Dir.	TEFC	PVC/PVC	10	1140	1	208-230/460 (3)	125	72630-0250

1,110 to 1,910 CFM — 3 to 2 inch Static Pressure

SIZE CODES -0250

Drive	Motor Enclosure	Material Wheel/Housing	Replacement* Parts	RPM	HP	Power Voltage (Phase)	Approx. Shipping (wt., lbs.)	Cat. No. and Size Codes
Dir.	XP	PP/PVC	9	1725	1-1/2	208-230/460 (3)	140	72521-0250
Dir.	TEFC	PP/PVC	9	1725	1-1/2	208-230/460 (3)	124	72531-0250
Dir.	XP	PVC/PVC	10	1725	1-1/2	208-230/460 (3)	140	72621-0250
Dir.	TEFC	PVC/PVC	10	1725	1-1/2	208-230/460 (3)	130	72631-0250
Belt	XP	PP/PVC	9	1725	1-1/2	208-230/460 (3)	160	72721-0250
Belt	TEFC	PP/PVC	9	1725	1-1/2	208-230/460 (3)	155	72731-0250
Belt	XP	PVC/PVC	10	1725	1-1/2	208-230/460 (3)	220	72821-0250
Belt	TEFC	PVC/PVC	10	1725	1-1/2	208-230/460 (3)	190	72831-0250

Blower Specifications

Industrial Blower Specifications These charts are arranged by increasing CFM. All blowers are 60Hz.

1,410 to 2,210 CFM — 1-1/4 to 1 inch Static Pressure

SIZE CODES -0310

Drive	Motor Enclosure	Material Wheel/Housing	Replacement* Parts	RPM	HP	Power Voltage (Phase)	Approx. Shipping (wt., lbs.)	Cat. No. and Size Codes
Dir.	XP	PP/PVC	11	1140	2	230/460 (3)	260	72520-0310
Dir.	TEFC	PP/PVC	11	1140	2	208-230/460 (3)	162	72530-0310
Dir.	XP	PVC/PVC	12	1140	2	230/460 (3)	195	72620-0310
Dir.	TEFC	PVC/PVC	12	1140	2	208-230/460 (3)	206	72630-0310

2,900 to 3,640 CFM — 3-1/4 to 2-3/4 inch Static Pressure

SIZE CODES -0310

Drive	Motor Enclosure	Material Wheel/Housing	Replacement* Parts	RPM	HP	Power Voltage (Phase)	Approx. Shipping (wt., lbs.)	Cat. No. and Size Codes
Dir.	XP	PP/PVC	11	1725	5	30/460 (3)	220	72521-0310
Dir.	TEFC	PP/PVC	11	1725	5	208-230/460 (3)	152	72531-0310
Dir.	XP	PVC/PVC	12	1725	5	230/460 (3)	225	72621-0310
Dir.	TEFC	PVC/PVC	12	1725	5	208-230/460 (3)	172	72631-0310
Belt	XP	PP/PVC	11	1725	5	230/460 (3)	277	72721-0310
Belt	TEFC	PP/PVC	11	1725	5	208-230/460 (3)	237	72731-0310
Belt	XP	PVC/PVC	12	1725	5	230/460 (3)	283	72821-0310
Belt	TEFC	PVC/PVC	12	1725	5	208-230/460 (3)	284	72831-0310

3,350 to 5,000 CFM — 3 to 2 inch Static Pressure

SIZE CODES -0400

Drive	Motor Enclosure	Material Wheel/Housing	Replacement* Parts	RPM	HP	Power Voltage (Phase)	Approx. Shipping (wt., lbs.)	Cat. No. and Size Codes
Dir.	XP	PP/PVC	13	1140	5	230-460 (3)	270	72520-0400
Dir.	TEFC	PP/PVC	13	1140	5	208-230/460 (3)	285	72530-0400
Dir.	XP	PVC/PVC	14	1140	5	230-460 (3)	300	72620-0400
Dir.	TEFC	PVC/PVC	14	1140	5	208-230/460 (3)	295	72630-0400
Belt	TEFC	PP/PVC	13	1140	5	208-230/460 (3)	370	72730-0400
Belt	TEFC	PVC/PVC	14	1140	5	208-230/460 (3)	380	72830-0400

COMMON REPLACEMENT PARTS *Match the replacement part number with the required item below.*

Call Saint-Gobain Performance Plastics for pricing on any housing, back plate or gasket.

Replacement No.	PVC Wheel	PP Wheel	Shaft Extension	Housing	Back Plate	Gasket
1	—	71309-0002	71309-0035	71309-0004	—	—
2	—	71409-0002	71409-0035/ 71409-0034*	71409-0031	—	—
3	71509-0003	—	Included	71409-0031	—	—
4	71509-0004	—	Included	71409-0031	—	—
5	—	72509-0160	Included	72509-0011	72509-0016	72509-0038
6	72609-0160	—	Included	72509-0011	72509-0016	72509-0038
7	—	72509-0200	Included	72509-0012	72509-0017	72509-0039
8	72609-0200	—	Included	72509-0012	72509-0017	72509-0039
9†	—	72509-0250** 72529-0250†	Included	72509-0013	72509-0018	72509-0040
10	72609-0250** 72629-0250†	—	Included	72509-0013	72509-0018	72509-0040
11	—	72509-0310	Included	72509-0014	72509-0019	72509-0041
12	72609-0310	—	Included	72509-0014	72509-0019	72509-0041
13	—	72509-0400	Included	72509-0015	72509-0020	72509-0042
14	72609-0400	—	Included	72509-0015	72509-0020	72509-0042

*The shaft extension of the 71420-0150 blower was redesigned in 1986. For blowers up to and including serial number 71E463109, order shaft extension 71409-0034. For blowers with higher serial numbers, order shaft extension 71409-0035.

†For blowers up to and including serial number 72E56243—will accept a motor with 0.625 diameter shaft.

**For serial numbers above 72E56243—will accept a motor with 0.875 diameter shaft.

Blower Specifications

LAB BLOWER—Dimensions (Inches)

Cat. No.	A	B	C	D	E	F	G	H	J	K
71330-0050	5-5/8	6-5/8	3-3/4	5-5/8	9	7	14-1/2	—	11	4-1/2
71320-0075	5-5/8	6-5/8	3-3/4	5-5/8	9	7	—	15-1/2	11	4-1/2
71430-, 71530-0050	9-1/2	7-1/4	4-1/2	8	10-1/2	7-1/4	19	—	15-1/8	8
71420-, 71520-0075	9-1/2	7-1/4	4-1/2	8	10-1/2	7-1/4	—	19-1/2	15-1/8	8
71430-, 71530-0100	9-1/2	7-1/4	4-1/2	8	10-1/2	7-1/4	18-1/2	—	15-1/8	8
71420-, 71520-0150	9-1/2	7-1/4	4-1/2	8	10-1/2	7-1/4	—	21-1/2	15-1/8	8

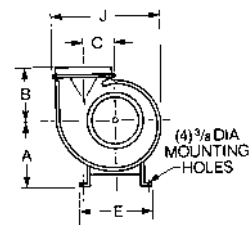
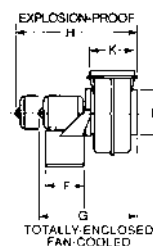

INDUSTRIAL BLOWERS WITH DIRECT DRIVE—Dimensions (Inches)

Cat. No.	Size Code	INLET DIAMETER, IN.		A	B	E	G	H	H1	K
		I.D.	O.D.							
72520, 72521	-0160	6-1/4	6-5/8	6	4-9/16	1/2	13-1/4	10	15-11/16	10
72530, 72531	-0200	7-3/8	7-3/4	7-7/16	5-1/8	1/2	14-1/2	14	21-11/16	10
72620, 72621	-0250	9-3/8	9-3/4	9-3/8	6-11/16	1/2	15-3/4	15-15/16	24-3/16	11-1/2
72630, 72631	-0310	12-3/8	12-3/4	11-7/8	9-11/16	1/2	17-1/4	20-15/16	31-9/16	13-1/2
	-0400	15-5/8	16	15-5/8	11-7/8	3/4	23	23-3/4	35-15/16	18

Cat. No.	Size Code	M	N	O	P	R	S	a	b
72520, 72521	-0160	16-1/2	9-1/16	15-3/8	5-11/16	5-13/16	12-3/8	8	6-9/16
72530, 72531	-0200	20-3/8	11-11/16	19-9/16	7-11/16	7-1/2	14-1/2	10-1/16	7-5/8
72620, 72621	-0250	24-1/4	13-9/16	22-13/16	8-1/4	8-7/16	16-5/8	11-7/8	9-3/16
72630, 72631	-0310	29-3/4	18-1/8	29-15/16	10-5/8	11-5/8	20-5/16	14-3/8	12-3/16
	-0400	39-3/4	22-7/16	36-13/16	12-3/16	13-9/16	24	18-3/8	14-5/8

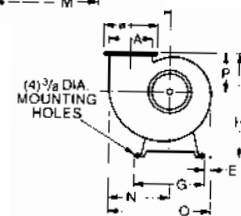
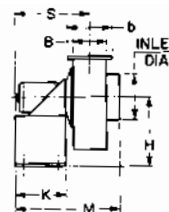

INDUSTRIAL BLOWERS WITH BELT DRIVE—Dimensions (Inches)

Cat. No.	Size Code	INLET DIA., IN.		A	B	E	G	H	H1	K	M
		I.D.	O.D.								
72721, 72730	-0160	6-5/8	6	4-9/16	1/2	32-1/2	10	15-11/16	10	22-1/4	
72731, 72821	-0200	7-3/4	7-7/16	5-1/8	1/2	32-1/2	14	21-11/16	10	22-1/4	
72830, 72831	-0250	9-3/4	9-3/8	6-11/16	1/2	37-1/4	15-15/16	24-3/16	11-1/2	26-3/4	
	-0310	12-3/4	11-7/8	9-11/16	1/2	46-13/16	20-15/16	31-9/16	13-1/2	32-1/4	
	-0400	16	15-5/8	11-7/8	3/4	54-9/16	23-3/4	35-15/16	18	41-7/8	

Cat. No.	Size Code	N	O	P	R	S	T	a	b
72721, 72730	-0160	9-1/16	15-3/8	5-11/16	5-13/16	16-3/8	14-7/8 +/- 1-1/2	8	6-9/16
72731, 72821	-0200	11-11/16	19-9/16	7-11/16	7-1/2	16-3/8	14-7/8 +/- 1-1/2	10-1/16	7-5/8
72830, 72831	-0250	13-9/16	22-13/16	8-1/4	8-7/16	19-1/8	16 +/- 1-1/2	11-7/8	9-3/16
	-0310	18-1/8	29-15/16	10-5/8	11-5/8	22-13/16	20-1/2 +/- 1-1/2	14-3/8	12-3/16
	-0400	22-7/16	36-13/16	12-3/16	13-9/16	26-1/8	22-7/8 +/- 1-1/2	18-3/8	14-5/8

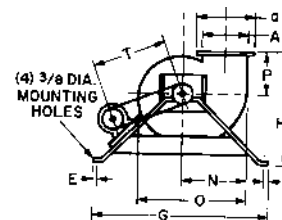
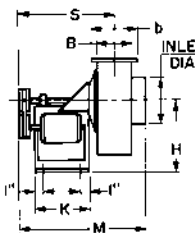

*Size codes for these blowers are available with all catalog numbers.

PVC DUCT TO BLOWER CONNECTION

You may attach PVC duct to the blower inlet and transition, or use the Saint-Gobain flexible connection.

INLET

Lab	INLET I.D. x O.D., IN.	Standard Duct Size IN.	Type of Duct Joint
71300 Series	5-1/4 x 5-5/8	5	Butts
71400 and 71500 Series	Taper x 8	8	Ducts slides over

Industrial	INLET I.D. x O.D., IN.	Standard Duct Size IN.	Type of Duct Joint
-0160	6-1/4 x 6-5/8	6	Butts
-0200	7-3/8 x 7-3/4	7	Ducts inserts
-0250	9-3/8 x 9-3/4	9	Ducts inserts
-0310	12-3/8 x 12-3/4	12	Butts
-0400	15-5/8 x 16	16	Butts

OUTLET

Lab	OUTLET I.D. x O.D., IN.	Standard Duct Size IN.	Type of Duct Joint
71300 Series	4 x 4-1/2	4	Butts
71400 and 71500 Series	Taper x 8	8	Ducts slides over

Industrial	OUTLET I.D. x O.D., IN.	Standard Duct Size IN.	Type of Duct Joint
-0160	6-1/4 x 6-5/8	6	Butts
-0200	8-1/4 x 8-5/8	8	Butts
-0250	10-3/8 x 10-3/4	10	Butts
-0310	13-5/8 x 14	14	Butts
-0400	15-5/8 x 16	16	Butts

Dir. = Direct Drive XP = Explosion-Proof TEFC = Totally Enclosed Fan-Cooled BELT = Belt Drive

Blower Specifications

Transitions for Saint-Gobain Performance Plastics Industrial Blowers

- Connect rectangular blower outlet to circular ductwork
- Permits fast, easy installation
- Rigid, welded PVC
- Flanges are drilled for blowers' bolt patterns

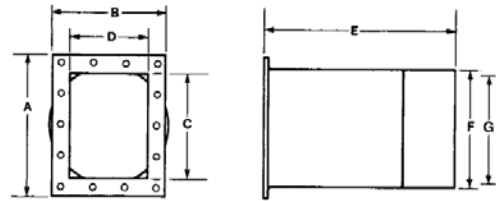
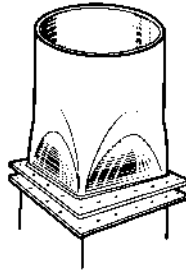

Cat. No.	Size Code	A	B	C	D	E	F Duct O.D.	G Duct I.D.	Bolt Holes
72510	-0160	8	6-9/16	5-7/8	4-3/8	11	6-5/8	6-1/4	14
Fits Saint-Gobain industrial blowers with these size codes	-0200	10-1/16	7-5/8	7-11/16	5-5/16	11	8-5/8	8-1/4	18
	-0250	11-7/8	9-3/16	9-1/2	6-3/4	12	10-3/4	10-3/8	22
	-0310	14-3/8	12-3/16	11-3/16	9-5/8	12	14	13-5/8	22
	-0400	18-3/8	14-5/8	15-3/4	12	13	16	15-5/8	22

Transitions for Saint-Gobain Industrial Blowers

- Easily fit inlets and outlets of laboratory blowers
- Stainless steel clamps (two) supplied for quick, easy installation
- Flexible PVC reduces excess vibration
- 6" Length

Connector Cat. No.	"A"—I.D. (Inches)	Connector Fits
72511-0050	4-1/2	5-inch lab blower (outlet)
72511-0055	5-5/8	5-inch lab blower (inlet)
72511-0100	8	8-inch lab blower (inlet and outlet)
72511-0160	6-5/8	-0160 industrial blower (inlet and transition)
72511-0200	7-3/4	-0200 industrial blower (inlet)
72511-0205	8-5/8	-0200 industrial blower (transition)
72511-0250	9-3/4	-0250 industrial blower (inlet)
72511-0255	10-3/4	-0250 industrial blower (transition)
72511-0310	12-3/4	-0310 industrial blower (inlet)
72511-0315	14	-0310 industrial blower (transition)
72511-0400	16	-0400 industrial blower (inlet and transition)

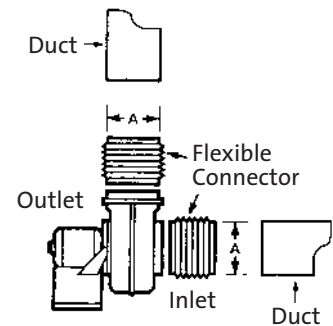

Lab Blower

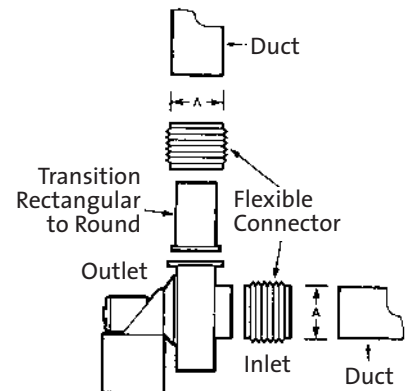

Industrial Blower

*Transitions are needed to convert the rectangular industrial blower outlet to a round duct. Must be ordered separately (Cat. No. 72510).

Technical Information

Food Grade Resins

The resins used in Saint-Gobain Performance Plastics low-density and high-density polyethylene tanks comply with 21 CFR Regulation 177.1520. These tanks may be used with the following kinds of food products:

- Nonacid, aqueous products; may contain salt or sugar or both (pH above 5.0)
- Dairy products and modifications: oil-in-water emulsions, high or low fat
- Moist bakery products with surface containing no free fat or oil
- Dry solids with the surface containing no free fat or oil (no end-test required) and under all conditions of use as described in Table 2 of 21 CFR Regulation 177.1520 except for condition A—high-temperature heat sterilization (e.g., over 100°C)

Saint-Gobain Performance Plastics rotomolded polypropylene complies with 21 CFR 177.1520 (c) 3.1 Regulation. The resin used in Saint-Gobain PVDF tanks complies with 21 CFR Regulation 177.2510.

Plastic Products for Biotechnology

Knowing whether a plastic is toxic to cell cultures is critical to biotechnology production. To test cytotoxicity, we submitted representative molded resin samples to an independent laboratory.

Samples were evaluated utilizing an MEM Elution Procedure, utilizing a W.I. 38 or MRC-5 cell line. This is a standard cytotoxicity test for pharmaceutical, medical devices and ophthalmic products (though it typically utilizes an L929 cell line.)

Dimensions and Wall Thickness

Dimensional information contained in this catalog is for reference only, for the

purpose of selecting product from the catalog. **There is no inference to tolerances for the listed approximate dimensions. For additional information, contact Saint-Gobain Performance Plastics.**

Physical Service Capabilities

Maximum service temperature listings refer to temperatures that should not be exceeded for the materials utilized in the specific product line. Many factors, such as chemical resistance, specific gravity, external stresses, product geometry, environment and many others affect the suitability of a particular product. For additional information, contact Saint-Gobain Performance Plastics.

Environmental Stress-Cracking

Environmental stress-cracking is the failure of a plastic material in the presence of certain types of chemicals. This failure is not a result of chemical attack. Simultaneous presence of three factors causes stress-cracking:

- Tensile stress
- A stress-cracking agent
- Inherent susceptibility of the plastic to stress-cracking

Tensile Stresses

These are set up during some molding and fabrication processes. Environmental conditions can add tensile stress, particularly if the tank is inadequately supported. Rotational molding creates parts that are virtually stress-free, so rotomolded tanks are less subject to environmental stress-cracking than fabricated tanks. Use of an FRP casing will minimize tensile stress from added load and further decrease the likelihood of environmental stress-cracking.

Common Stress-Cracking Agents

Detergents, surface active chemicals, lubricants, oils, ultra-pure water and plating additives such as brightener and wetting agents.

Relatively small concentrations of stress-cracking agent may be sufficient to cause cracking. (Stress cracking agents are identified in the Chemical Resistance Chart.)

Susceptibility to Stress-Cracking

This varies from plastic to plastic depending on several characteristics of the molecular structure. Cross-linked high-density polyethylene is inherently more resistant to stress-cracking than either low- or high-density polyethylene. PVDF also has excellent stress-crack resistance.

Physical Service Capabilities

Prolonged use of a plastic tank at temperatures above ambient will shorten tank life. Temperature effects are directly dependent on the characteristics of the plastic resin, specific gravity of tank contents, tank size and configuration, exterior support, and wall thickness of the tank.

Temperature cycling will shorten tank life. The impact resistance of most rotomolded tanks declines at low temperatures. Cross-linked high-density polyethylene retains much of its impact resistance in low temperature applications.

Ultraviolet (UV) Stabilization

Plastics are attacked and deteriorate when exposed to direct sunlight. When plastic tanks absorb the sun's ultraviolet light, the UV energy excites the polymers' chains, causing them to break. The effects are discoloration, embrittlement and eventual cracking. Elevated temperatures and oxygen tend to accelerate the deterioration. Those Saint-Gobain Performance Plastics tanks listed as suitable for outdoor service are protected from UV attack by: coloring or pigmenting and/or adding internal stabilizers which preferentially absorb or dissipate the UV energy. Shading tanks from the sun will also prevent deterioration.

Tanks must be free to expand or contract; avoid excessive tension on the tank.

Resins Non-Toxic to Cell Cultures *Contact Saint-Gobain for details, 800-451-0770.*

Resin	Color	Product
High-Density Polyethylene (HDPE)	Natural	Tanks
Low-Density Polyethylene (LDPE)	Natural	Tanks
Polypropylene (PP)	Natural	Tanks
Polyvinylidene Fluoride (PVDF)	Natural	Tanks

Chemical Storage

Storage of Sodium Hypochlorite (NaOCl) in Polyethylene Tanks

Some concerns have been expressed to Saint-Gobain Performance Plastics regarding the storage of sodium hypochlorite in polyethylene tanks.

Although polyethylene storage tanks have been used for storage of sodium hypochlorite in the field for many years, there have been premature failures in very specific locales. We have reviewed all data available on the chemistry and technology of sodium hypochlorite storage, and we have the following information:

Sodium hypochlorite (NaOCl) has no direct effect on polyethylene. This has been confirmed by the resin suppliers. It is suspected however, that contaminated sodium hypochlorite does cause accelerated deterioration of polyethylene

tanks when stored over a period of time. Contamination such as trace metals, e.g. iron, copper, etc., which may be generated from pumps, plumbing, fittings, etc., or a poor quality (trace contamination) sodium hypochlorite shipment, may cause brittleness and cracking of the polyethylene tanks.

We feel the main contributor to premature failure of polyethylene storage tanks is contamination; the presence of sunlight catalyzes/accelerates the rate of attack on polyethylene. **Saint-Gobain Performance Plastics will only warrant tanks for the storage of sodium hypochlorite if the following specifications are met:**

- Heavy-walled tanks (bulk tanks, 1.9 specific gravity)
- Cross-linked polyethylene (XLPE)

We recommend the following steps to be taken by the end user:

- Flush/clean tanks periodically to remove contaminants and deposits
- Check quality of received NaOCl (chemical analysis/purity)
- Check plumbing, pumps and delivery methods for materials of construction

We wish to emphasize that non-contaminated sodium hypochlorite storage in polyethylene is an acceptable and compatible combination. It appears that cracking and premature tank failures occur only when sodium hypochlorite is contaminated with trace amounts of metals and subjected to sunlight.

A Guide To Using Saint-Gobain Performance Plastics Tanks With Most Common Chemicals

The resins used in Saint-Gobain Performance Plastics tanks are highly resistant to many chemicals. This chart will assist in the selection of tank material for use with common chemicals. Mechanical stress, high temperatures, and extended use tend to multiply the effects of chemicals on the tank.

Such effects should be taken into account when using Saint-Gobain Performance Plastics tanks for long-term chemical storage or with handling equipment. Under normal conditions, chemicals rated "S" may be safely handled by the plastic material. Chemicals rated "U" are not recommended for storage in that particular material.

This chart applies to tank materials at temperatures from 70°F/21°C to 140°F/60°C.

Storage of flammables in plastic tanks must conform to local fire codes.

Mixing and/or dilution of certain chemicals in Saint-Gobain Performance Plastics tanks can be potentially dangerous. The reactive combination of different chemicals or compounds of two or more classes may cause an undesirable chemical effect or result in an increased temperature which can affect chemical resistance. Small amounts of certain chemicals can drastically change the characteristics of the blend. As temperature increases, resistance to attack decreases.

Chemicals can affect the strength, flexibility, surface appearance, color, dimensions or weight of plastics. The basic modes of interaction which cause these changes are: (1) chemical attack on the polymer chain, with resultant reduction in properties, including **oxidation** and **depolymerization**; (2) physical change, including absorption of solvents, resulting in softening and swelling of the

plastic; **permeation** of solvent through the plastic; **dissolution** in a solvent; and stress-cracking from the interaction of a **stress-cracking** agent with molded-in or external stresses.

NOTE: The chemical resistance information in this chart is a general guide only. Because many factors can affect chemical resistance, you should test under your own conditions. If any doubt exists about specific applications of Saint-Gobain tanks, please contact Saint-Gobain Performance Plastics, 460 Milltown Road, Bridgewater, NJ 08807 or call (800) 435-3992, fax (908) 218-9009.

ATTENTION: Please be aware that, although several plastics may have excellent resistance to various flammable or combustible chemicals or solvents, safety regulations for storage or other local regulations may restrict storage of these chemicals in tanks.

Chemical Resistance

Description	% Conc.	LLDPE/LDPE/ HDPE		XLPE1		PP		PVDF		FRP		PVC		EPDM	NEOPRENE	VITON®	316 STAINLESS
		70°F	140°F	70°F	140°F	70°F	140°F	70°F	140°F	70°F	140°F	70°F	140°F	70°F	70°F	70°F	70°F
Acetaldehyde*	40	U	U	U	U	U	U	U	U	U	U	U	U	S	U	U	S
Acetamide		—	—	—	—	S	U	S	U	—	—	—	—	S	S	S	S
Acetic Acid*/**	1-79	U	U	S	S	U	U	S	S	S	S	S	S	U	U	U	S
Acetic Acid*/**	80-100	U	U	S	U	U	U	S	U	S	U	U	U	—	—	—	S
Acetic Anhydride		U	U	U	U	U	U	—	U	U	U	—	U	U	S	S	U
Acetone*†		U	U	U	U	U	U	U	U	U	U	U	U	S	U	U	S
Acrylic Emulsions*		U	U	S	U	U	U	—	—	S	U	—	—	—	—	—	—
Acrylonitrile		—	—	—	—	S	U	S	U	—	—	U	U	U	U	U	S
Adipic Acid		S	S	S	S	S	S	S	S	S	—	S	S	—	—	—	S
Alcohol:																	
Allyl*		U	U	S	S	S	S	S	S	S	S	U	U	—	—	—	—
Amyl*/**		S	S	S	S	S	U	S	S	S	S	U	U	S	S	S	S
Bensyl*		—	—	—	—	S	S	S	S	—	—	U	U	U	U	S	S
Butyl*		U	U	S	S	S	S	S	S	S	S	—	S	S	S	S	S
Diacetone*		—	—	—	—	S	—	S	U	—	—	—	—	S	S	U	S
Ethyl*		U	U	S	S	S	S	S	S	S	S	S	S	—	S	S	S
Hexyl*		—	—	—	—	—	—	S	S	—	—	S	S	S	S	S	S
Isobutyl*		—	—	—	—	—	—	S	S	—	—	S	—	S	—	S	S
Isopropyl*		—	—	S	U	S	—	S	S	—	—	S	S	S	S	S	S
Methyl*		—	—	S	S	S	—	S	S	—	—	S	S	S	S	S	S
Propyl*		—	—	S	S	S	—	S	S	—	—	S	S	S	S	S	S
Aluminum Salts	Conc.	S	S	S	S	S	S	S	S	S	S	S	S	S	S	S	U
Aluminum Hydroxide	10%	—	—	S	S	S	—	S	S	—	—	S	S	S	—	S	S
Alums (All Types)	Conc.	S	S	S	S	S	S	S	S	S	S	S	S	S	S	S	S
Ammonia, Dry Gas	100	S	S	S	S	S	S	U	U	S	S	S	S	S	S	—	S
Ammonia, Solution	30	U	U	S	S	S	S	S	S	S	U	S	S	S	S	S	—
Ammonium Salts		S	S	S	S	S	S	S	S	S	S	S	S	S	S	—	U
Amyl Acetate*†	100	U	U	U	U	U	U	S	U	S	U	U	U	S	U	U	—
Amyl Chloride	100	U	U	U	U	U	U	S	S	S	U	U	U	—	—	—	—
Aniline*	100	U	U	U	U	U	U	S	U	—	—	U	U	S	U	S	—
Antifreeze*/**		U	U	S	S	S	U	S	S	S	S	S	S	S	S	S	S
Antimony Chloride		S	S	S	S	S	U	S	U	S	S	S	S	—	—	S	—
Aqua Regia*		U	U	U	U	U	U	S	U	U	U	U	U	U	U	U	U
Arsenic Acid	80	S	S	S	S	S	S	S	S	—	—	S	S	—	—	S	S
Barium Salts		S	S	S	S	S	S	S	S	S	S	S	S	S	S	S	S
Benzadolehyde*	10	U	U	U	U	S	U	S	U	—	—	S	S	S	U	U	S
Benzene*		U	U	U	U	U	U	S	S	S	U	—	—	U	U	S	U
Benzene Sulfonic Acid*/**	10	U	U	S	U	S	S	S	U	S	S	S	S	—	—	S	—
Benzoic Acid	All Conc.	S	S	S	S	S	S	S	S	S	S	—	—	—	U	S	—
Black Liquor ²								S	S			S	S	S	—	S	—
Bleach	10	U	U	S	S	S	S	S	S	S	S	S	—	S	U	S	—
See statement on NaOCl storage in Technical Data section																	
Borax	Satd.	S	S	S	S	S	S	S	S	S	S	S	—	S	S	S	S
Boric Acid	Conc.	S	S	S	S	S	S	S	S	S	S	—	—	S	S	S	S
Bromine Gas	Weak Conc.	U	U	U	U	U	U	S	S	S	S	U	U	—	U	S	—
Bromine Liquid	100	U	U	U	U	U	U	S	S	—	—	U	U	—	U	S	—
Bromine Water †		U	U	U	U	U	U	S	S	—	—	U	U	—	—	S	U
Butadiene		—	—	—	—	—	—	S	S	—	—	U	U	S	—	S	S
Butane		—	—	—	—	S	—	S	S	—	—	U	U	U	S	S	S
Butanediol*	100	U	U	S	S	U	U	S	S	—	—	—	—	—	—	—	—
Butyl Acetate †	100	U	U	S	U	U	U	S	U	S	U	U	U	—	U	—	S
Butyl Alcohol*	100	U	U	S	S	U	U	S	S	S	S	—	—	—	S	S	—
Butylene		—	—	—	—	—	—	S	U	—	—	S	S	U	—	S	S
Butyric Acid	80	U	U	—	—	S	S	S	S	S	U	U	U	—	—	S	—

See page 44 for chart and footnote legend.

Chemical Resistance

Description	% Conc.	LLDPE/LDPE/ HDPE		XLPE1		PP		PVDF		FRP		PVC		EPDM	NEOPRENE	VITON®	316 STAINLESS
		70°F	140°F	70°F	140°F	70°F	140°F	70°F	140°F	70°F	140°F	70°F	140°F	70°F	70°F	70°F	70°F
Cadmium Salts		S	S	S	S	S	S	S	S	S	S	-	-	-	S	S	-
Calcium Salts		S	S	S	S	S	S	S	S	S	S	S	S	S	U	S	S
Calcium Hypochlorite**		S	S	S	S	S	S	S	S	S	S	-	-	-	U	S	-
Calgon (sodium hexmeta phosphate)*		U	U	S	S	U	U	S	S	-	-	-	-	-	S	-	S
Camphor Oil		U	U	U	U	U	U	-	-	-	-	-	-	-	-	-	S
Carbon Bisulfide* (disulfide)		U	U	U	U	U	U	S	U	-	-	U	U	U	U	S	U
Carbon Dioxide, wet/dry	100	S	S	S	S	S	S	S	S	S	S	S	S	-	S	S	S
Carbon Monoxide		S	S	S	S	S	S	S	S	S	S	S	S	-	S	S	S
Carbon Tetrachlorid†		U	U	U	U	U	U	S	S	U	U	U	U	U	U	S	S
Carbonic Acid		S	S	S	S	S	S	S	S	S	S	S	S	S	S	S	S
Castor Oil*		U	U	S	S	U	U	S	S	-	-	S	S	-	S	S	S
Caustic Soda*	10	U	U	S	S	S	S	S	S	-	-	S	S	S	S	S	S
Caustic Soda*	Conc.	U	U	S	S	S	-	U	U	S	U	S	S	S	S	-	U
Chlorine Gas, Dry	100	U	U	U	U	U	U	S	S	S	S	U	U	U	U	S	-
Chlorine Liquid		U	U	U	U	U	U	S	S	-	-	U	U	-	U	-	-
Chlorine Water	Satd.	S	U	S	U	U	U	S	S	S	S	S	S	-	U	-	-
Chloroacetic Acid*	100	U	U	U	U	U	U	S	U	S	U	S	U	S	S	U	U
Chlorobenzene*†		U	U	U	U	U	U	S	U	S	U	U	U	U	U	S	S
Chloroform*†		U	U	U	U	U	U	S	U	-	-	U	U	U	U	S	S
Chlorosulfonic Acid*		U	U	U	U	U	U	U	U	-	-	U	U	U	U	U	U
Chrome Alum	Satd.	S	S	S	S	S	S	S	S	-	-	S	S	S	S	U	S
Chromic Acid	20	S	U	S	S	U	U	S	S	-	-	S	U	U	U	S	S
Chromic Acid**	50	U	U	S	U	U	U	S	U	-	-	U	U	U	U	S	S
Chromic Acid & 50% Sulfuric Acid*/**		U	U	S	U	U	U	S	U	U	U	U	U	U	U	U	U
Citric Acid*	Satd.	U	U	S	S	S	S	S	S	S	S	S	S	-	S	S	S
Coconut Oil Derivatives		S	S	S	S	S	S	S	S	S	S	S	S	-	S	S	S
Cottonseed Oil*		U	U	S	S	S	S	S	S	S	S	S	S	S	S	S	-
Cresol*		U	U	S	U	U	U	S	S	-	-	U	U	U	U	S	S
Cresylic Acid		U	U	U	U	U	U	S	S	-	-	S	U	U	U	S	S
Cupric Salts		S	S	S	S	S	S	S	S	-	-	S	S	S	S	S	U
Cuprous Salts		S	S	S	S	S	S	S	S	-	-	S	S	S	S	S	U
Cyclohexane		U	U	U	U	U	U	S	S	S	S	U	U	U	U	S	S
Cyclohexanone*		U	U	U	U	U	U	S	U	S	U	U	U	-	-	-	S
Detergents*		U	U	S	S	U	U	S	S	S	S	S	S	-	S	S	S
Developers, Photographic		S	S	S	S	S	S	S	S	S	S	S	S	-	-	-	S
Dextrin	Satd.	S	S	S	S	S	S	S	S	S	S	S	S	S	S	S	-
Dextrose	Satd.	S	S	S	S	S	S	S	S	-	-	S	S	S	S	S	-
Diazo Salts		S	S	S	S	S	S	-	-	-	-	S	S	-	-	-	-
Diesel Fuel		-	-	S	U	S	U	S	S	S	S	S	U	U	U	S	S
Diethylamine		U	U	-	-	S	U	S	U	S	S	U	U	U	S	U	S
Diethylene Glycol*		U	U	S	S	S	U	-	-	S	S	-	-	-	S	-	S
Diethylphthalate*		U	U	U	U	U	U	U	U	S	U	U	U	-	U	-	S
Disodium Phosphate		S	S	S	S	S	S	S	S	-	-	S	S	-	-	S	S
Emulsions, Photographic*		U	U	S	S	U	U	S	S	-	-	S	S	-	-	-	-
Epsom Salts (Magnesium Sulfate)		S	S	S	S	S	S	S	S	S	S	S	S	S	S	S	S
Ethyl Acetate*	100	U	U	U	U	U	U	U	U	-	-	U	U	-	U	-	S
Ethyl Alcohol*	100	U	U	S	S	S	S	S	S	S	U	S	S	-	S	S	S
Ethyl Bromide		U	U	U	U	U	U	S	S	-	-	U	U	-	-	S	S
Ethyl Chlorid†		U	U	U	U	U	U	S	S	-	-	U	U	S	U	S	S
Ethyl Ether		U	U	U	U	U	U	S	U	-	-	U	U	-	U	-	S
Ethylene Chloride		U	U	U	U	U	U	S	S	S	S	U	U	U	U	S	S
Ethylene Dichloride*		U	U	U	U	U	U	S	S	-	-	U	U	U	U	S	S
Ethylene Glycol**		U	U	S	S	S	U	S	S	-	-	S	S	S	S	S	S
Ethylene Oxide	12	U	U	U	U	S	U	S	U	-	-	U	U	U	U	U	-

Chemical Resistance

Description	% Conc.	LLDPE/LDPE/HDPE		XLPE1		PP		PVDF		FRP		PVC		EPDM	NEOPRENE	VITON®	316 STAINLESS
		70°F	140°F	70°F	140°F	70°F	140°F	70°F	140°F	70°F	140°F	70°F	140°F	70°F	70°F	70°F	70°F
Fatty Acids*		U	U	S	S	S	U	S	S	S	S	S	U	U	U	S	S
Ferric Chloride		S	S	S	S	S	S	S	S	S	S	S	S	S	S	S	U
Ferric Salts		S	S	S	S	S	S	S	S	S	S	S	S	S	S	S	U
Ferrous Salts		S	S	S	S	S	S	S	S	S	S	S	S	S	S	S	-
Fish Solubles*		U	U	S	S	U	U	-	-	S	S	S	S	-	-	-	-
Fluoboric Acid		S	S	S	S	S	S	S	S	S	S	S	S	-	S	S	U
Fluorine, Dry		U	U	U	U	U	U	S	U	U	U	U	U	-	-	S	S
Fluosilicic Acid	32	S	S	S	S	S	S	S	S	S	U	S	S	-	-	S	-
Fluosilicic Acid	Conc.	S	U	S	U	S	U	S	S	S	U	-	-	-	-	S	-
Formaldehyde**	40	U	U	S	U	S	U	S	U	S	U	U	U	S	S	S	S
Formic Acid*	100	U	U	S	S	S	U	S	S	S	U	U	U	S	S	U	-
Freon 11		-	-	-	-	-	-	U	U	-	-	U	U	U	S	U	S
Freon 113		-	-	-	-	-	-	S	S	-	-	S	S	U	S	U	S
Freon 12		S	U	S	U	S	U	S	S	-	-	U	U	-	S	U	-
Fructose	Satd.	S	S	S	S	S	S	S	S	S	S	S	S	S	S	S	S
Fruit Juice		S	S	S	S	S	S	S	S	-	-	S	S	U	U	S	S
Fruit Pulp*		U	U	S	S	S	S	S	S	S	S	S	S	U	S	S	S
Fuel Oil*		U	U	S	U	U	U	S	S	S	S	S	S	U	S	S	S
Gallic Acid*	Satd.	U	U	S	S	S	S	S	U	-	-	S	S	-	S	S	-
Gasoline*†		U	U	S	U	U	U	S	S	S	S	S	U	U	U	S	S
Gelatin		S	S	S	S	S	-	S	S	-	-	S	S	S	S	S	S
Gin*		U	U	S	U	S	S	S	S	-	-	-	-	-	-	-	-
Glucose		S	S	S	S	S	S	S	S	S	S	S	S	S	S	S	S
Glue, P.V.A.		-	-	-	-	S	-	S	S	-	-	-	-	-	S	S	S
Glycerol*		U	U	S	S	S	S	S	S	S	S	S	U	S	S	S	S
Glycolic Acid*	30	U	U	S	S	S	S	S	U	S	S	S	S	-	-	S	S
Glycols**		U	U	S	S	S	U	S	S	S	S	-	-	-	-	-	S
Gold Monocyanide		S	S	S	S	S	S	S	S	S	S	S	S	-	S	S	S
Grape Juice		-	-	S	S	-	-	S	S	-	-	S	S	-	S	S	S
Grape Sugar	Satd.	S	S	S	S	S	S	S	S	S	S	S	S	-	-	S	-
Grease		U	U	S	S	S	U	S	S	-	-	S	S	-	U	S	S
Heptane*†		U	U	S	U	U	U	S	S	S	S	S	S	U	U	S	S
Hexane*†		U	U	S	U	U	U	S	S	S	U	U	U	U	U	S	S
Honey		S	S	S	S	S	S	S	S	S	S	S	S	S	S	S	S
Hydraulic Oils (Petroleum)		U	U	S	U	U	U	S	U	U	U	U	U	U	S	U	S
Hydraulic Oils (Synthetic)		U	U	S	U	U	U	S	U	U	U	U	U	-	U	S	S
Hydrazine		-	-	S	S	-	-	S	S	-	-	U	U	S	S	S	S
Hydrobromic Acid	37	S	S	S	S	U	U	S	S	U	U	S	U	-	-	S	U
Hydrochloric Acid ⁴	20	S	S	S	S	S	S	S	S	-	-	S	S	S	S	S	U
Hydrochloric Acid ⁴	37	S	S	S	S	S	S	S	S	-	-	S	S	U	U	S	U
Hydrocyanic Acid	Satd.	S	S	S	S	S	S	S	S	S	-	S	S	S	S	S	-
Hydrofluoric Acid	50	S	U	S	S	S	-	S	S	-	-	S	U	U	S	S	U
Hydrofluoric Acid	75	-	-	S	S	S	-	S	S	-	-	U	U	U	U	S	U
Hydrofluosilicic Acid	32	S	S	S	S	S	S	S	S	S	U	S	S	-	-	S	S
Hydrofluosilicic Acid	Conc.	S	U	S	S	S	U	S	S	S	U	S	S	-	-	S	-
Hydrogen	100	S	S	S	S	S	S	S	S	S	S	S	S	S	S	S	S
Hydrogen Chloride Gas, Dry		S	S	S	S	S	S	S	S	S	S	-	-	-	-	-	-
Hydrogen Peroxide	30	S	S	S	S	S	U	S	S	S	S	S	-	S	S	S	S
Hydrogen Phosphide	100	S	S	S	S	-	-	S	U	-	-	S	S	-	-	-	-
Hydrogen Sulfide		S	S	S	S	S	S	S	S	S	S	S	S	S	S	S	S
Hydrogen Sulfide, Aqueous Sol'n		S	S	S	S	S	U	S	S	-	-	S	S	S	U	S	S
Hydroquinone		S	S	S	S	S	S	S	S	-	-	S	S	-	U	S	-
Hypochlorous Acid	Conc.	S	S	S	S	S	S	S	U	S	S	S	S	-	-	S	-
Inks*		U	U	S	S	S	S	S	U	-	-	-	-	-	-	-	S
Iodine		-	-	-	-	U	U	S	S	-	-	U	U	U	U	S	U
Iodine (K Solution)	Conc.	U	U	U	U	U	U	-	-	-	-	-	-	-	-	-	-

See page 44 for chart and footnote legend.

Chemical Resistance

Description	% Conc.	LLDPE/LDPE/HDPE		XLPE1		PP		PVDF		FRP		PVC		EPDM	NEOPRENE	VITON®	316 STAINLESS
		70°F	140°F	70°F	140°F	70°F	140°F	70°F	140°F	70°F	140°F	70°F	140°F	70°F	70°F	70°F	70°F
Isopropyl Alcohol*		U	U	S	U	S	U	S	S	-	-	S	U	S	S	S	S
Isopropyle Ether		-	-	-	-	-	-	S	U	-	-	-	-	U	U	U	S
Isooctane		-	-	-	-	-	-	S	S	-	-	-	-	S	S	S	S
Jet Fuel (JP3, JP4, JP5)		-	-	-	-	S	U	S	S	-	-	S	U	U	U	S	S
Kerosene*		U	U	S	U	S	U	S	S	S	S	S	U	U	U	S	S
Ketones		-	-	-	-	S	-	U	U	-	-	U	U	S	U	U	S
Lactic Acid*	90	U	U	S	U	S	U	S	U	S	S	S	-	S	S	S	-
Lard Oil		U	U	S	U	U	U	S	U	-	-	S	U	U	U	S	S
Latex*		U	U	S	S	S	S	-	-	-	-	-	-	U	S	S	S
Lead Acetate	Satd.	S	S	S	S	S	S	S	S	S	S	S	S	-	-	S	-
Lime	30	-	-	S	S	S	U	-	-	-	-	S	U	S	S	S	-
Linseed Oil*		U	U	S	U	S	S	S	S	S	S	S	S	-	S	S	S
Lube Oil*		U	U	S	U	S	U	S	S	-	-	S	U	-	-	S	S
Magnesium Salts		S	S	S	S	S	S	S	S	S	S	S	S	S	S	S	S
Maleic Acid		S	U	S	U	S	U	S	S	-	-	S	S	U	U	S	S
Mercuric Salts	Satd.	S	S	S	S	S	S	S	S	S	S	S	S	S	S	S	U
Mercurous Salts	Satd.	S	S	S	S	S	S	S	S	S	S	S	S	S	S	S	-
Mercury		S	S	S	S	S	S	S	S	S	S	S	S	S	S	S	S
Methyl Acetate		-	-	-	-	-	-	S	U	-	-	U	U	U	U	U	S
Methyl Alcohol*	100	U	U	S	S	S	S	S	S	S	U	S	U	S	S	S	S
Methyl Bromide		U	U	U	U	U	U	S	S	-	-	U	U	U	U	S	S
Methyl Butyl Ketone		-	-	-	-	U	U	U	U	-	-	U	U	S	U	U	S
Methyl Cellosolve		-	-	-	-	S	U	S	S	-	-	U	U	U	U	U	S
Methyl Chloride*		U	U	U	U	U	U	S	S	-	-	U	U	U	U	S	S
Methyl Isobutyl Ketone		-	-	-	-	U	U	U	U	-	-	U	U	U	U	U	S
Methyl Ethyl Ketone*†	100	U	U	U	U	S	U	U	U	-	-	U	U	S	U	-	S
Methyl Methacrylate		-	-	-	-	-	-	S	U	-	-	S	-	U	U	U	-
Methyl Sulfuric Acid*		U	U	S	U	S	U	S	U	S	S	S	U	-	-	-	-
Methylamine		-	-	-	-	-	-	U	U	-	-	U	U	-	-	-	S
Methylene Chloride*	100	U	U	U	U	U	U	U	U	-	-	U	U	-	U	-	-
Milk		S	S	S	S	S	S	S	S	-	-	S	S	S	S	S	S
Mineral Oils		U	U	S	U	S	U	S	S	S	S	S	U	-	S	S	S
Molasses	Comm.	S	S	S	S	S	S	S	S	S	S	S	S	U	-	-	S
Naphtha*		U	U	U	U	S	U	S	S	S	S	S	U	U	U	S	S
Naphthalene*		U	U	U	U	S	U	S	S	S	S	U	U	U	U	S	S
Nickel Salts		S	S	S	S	S	S	S	S	S	S	S	S	-	S	S	U
Nicotine*	Dilute	U	U	S	S	S	S	S	U	-	-	S	S	-	-	-	-
Nicotinic Acid*		U	U	S	S	S	S	S	S	-	-	S	S	-	-	-	-
Nitric Acid**	0-29	S	S	S	S	S	U	S	U	S	U	S	S	-	U	S	S
Nitric Acid**	30-49	S	U	S	U	U	U	S	U	S	U	U	U	U	U	S	S
Nitric Acid**	50-69	U	U	U	U	U	U	U	U	-	-	U	U	-	U	S	S
Nitric Acid**	70-98	U	U	U	U	U	U	U	U	U	U	U	U	-	U	U	-
Nitrobenzene*	100	U	U	U	U	U	U	S	U	-	-	U	U	S	U	U	S
Oils*																	
Essential		-	-	-	-	-	-	S	S	-	-	-	-	-	U	-	S
Mineral		-	-	S	U	-	-	S	S	-	-	S	U	-	S	S	S
Vegetable		-	-	S	U	-	-	S	S	-	-	S	U	-	S	S	S
Lubricating		-	-	S	U	-	-	S	S	-	-	S	U	-	S	S	S
Oils and Fats*		U	U	S	U	S	U	S	S	S	S	S	U	-	S	S	S
Oleic Acid	Conc.	U	U	S	U	S	U	S	S	S	S	S	U	U	U	S	S
Oleum		U	U	U	U	U	U	U	U	-	-	U	U	U	U	S	-
Orange Extract		S	S	S	S	S	S	S	S	-	-	-	-	-	-	-	-
Oxalic Acid	Satd.	S	U	S	U	S	S	S	U	S	S	S	U	-	S	S	-
Ozone		U	U	U	U	U	U	S	S	-	-	S	U	U	-	S	S
Palmitic Acid		S	U	S	U	S	U	S	S	S	S	S	U	-	-	S	S
Paraffin		-	-	-	-	S	U	S	S	-	-	S	U	U	-	S	S

Chemical Resistance

Description	% Conc.	LLDPE/LDPE/HDPE		XLPE1		PP		PVDF		FRP		PVC		EPDM	NEOPRENE	VITON®	316 STAINLESS
		70°F	140°F	70°F	140°F	70°F	140°F	70°F	140°F	70°F	140°F	70°F	140°F	70°F	70°F	70°F	70°F
Pentane		–	–	–	–	–	–	–	–	–	–	–	–	U	U	S	U
Perchloric Acid	10	S	S	S	S	S	S	S	S	S	U	S	U	–	–	S	U
Perchloroethylene		U	U	U	U	U	U	S	S	–	–	U	U	U	U	S	S
Phenol Carbolic Acid	5	S	U	S	U	S	S	S	S	–	–	S	U	U	U	S	–
Phosphoric Acid	50	S	S	S	S	S	S	S	S	S	S	S	U	S	S	S	S
Phosphoric Acid	85	S	U	S	S	S	U	S	S	S	S	S	U	S	S	S	–
Phosphorus Pentoxide	100	S	U	S	U	S	U	S	S	–	–	S	–	–	–	–	–
Phosphorus Trichloride	100	U	U	–	–	U	U	S	S	–	–	U	U	–	–	–	S
Photographic Solutions*		S	U	S	S	S	S	S	S	S	U	S	S	–	S	–	–
Pickling Baths, Hydrochloric Acid*		U	U	S	S	S	S	–	–	S	S	–	–	–	–	–	–
Pickling Baths, Sulfuric Acid*		U	U	S	S	S	S	–	–	S	S	–	–	–	–	S	–
Pickling Baths, Sulfuric-Nitric/**		U	U	S	U	S	U	–	–	S	U	U	U	–	–	S	–
Picric Acid*	1	U	U	S	U	S	U	S	U	S	S	U	U	U	S	S	–
Plating Solutions Without Wetting Agents**		S	U	S	U	S	U	S	U	S	U	S	U	–	S	S	S
Potassium Salts		S	S	S	S	S	S	S	S	S	S	S	S	S	S	S	–
Potassium Hydroxide*	0-10	U	U	S	U	S	U	S	U	U	U	S	S	S	U	S	U
Propane		–	–	–	–	–	–	S	S	–	–	S	U	U	S	S	S
Propyl Alcohol*		U	U	S	S	S	S	–	–	–	–	S	U	–	S	S	S
Propylene Glycol*		U	U	S	S	S	U	S	S	S	S	–	–	–	U	S	S
Pyridine*		U	U	S	U	S	S	U	U	–	–	U	U	U	U	U	U
Pyrogallic Acid		–	–	–	–	S	U	S	U	–	–	S	U	–	–	S	S
Rayon Coagulating Bath*		U	U	S	S	S	S	–	–	–	–	S	S	–	–	–	–
Selenic Acid		S	S	S	S	S	U	S	S	–	–	S	S	–	–	–	–
Shortening*		U	U	S	S	S	S	–	–	–	–	–	–	–	–	–	–
Silicic Acid		S	S	S	S	S	S	S	S	S	S	S	S	–	–	S	–
Silver Salts		S	S	S	S	S	S	S	S	S	S	S	S	S	S	S	S
Soap Solution*	Any Conc.	U	U	S	S	U	U	S	U	S	S	S	S	S	S	S	S
Soda Ash		S	S	S	S	S	S	S	S	U	U	S	S	S	S	S	S
Sodium Salts		S	S	S	S	S	S	S	S	S	S	S	S	S	S	S	S
Sodium Hexametaphosphate*		U	U	S	S	U	U	–	–	–	–	–	–	–	S	–	S
Sodium Hydroxide*	10	U	U	S	S	S	S	S	S	–	–	S	S	S	S	S	S
Sodium Hydroxide*	Conc.	U	U	S	S	S	–	U	U	S	U	S	S	S	S	–	U
Sodium Hypochlorite** See NaOCl Storage statement, Pg 38.		U	U	S	S	U	U	S	S	S	S	S	–	S	U	S	U
Sour Crude*		U	U	S	U	S	U	S	S	S	S	S	S	–	–	S	–
Stannic Salts		S	S	S	S	S	S	S	S	S	S	S	S	S	–	S	–
Stannous Salts		S	S	S	S	S	S	S	S	S	S	S	S	S	S	S	–
Starch Solution	Satd.	S	S	S	S	S	S	S	S	S	S	S	S	–	–	S	S
Stearic Acid*	100	U	U	S	S	S	S	S	S	S	S	U	U	–	S	S	S
Stoddard's Solvent		–	–	–	–	U	U	S	S	–	–	U	U	U	U	S	S
Styrene Monomer		–	–	–	–	–	–	S	S	–	–	U	U	U	U	S	S
Sulfur		S	U	S	U	S	U	S	S	–	–	U	U	S	S	S	S
Sulfur Chloride		U	U	U	U	U	U	S	U	–	–	U	U	U	U	S	U
Sulfur Dioxide**		S	U	S	U	S	U	S	S	S	S	U	U	S	S	S	S
Sulfuric Acid ³ **	0-49	S	S	S	S	S	S	S	S	S	S	S	S	–	S	S	U
Sulfuric Acid ³ **	51-74	U	U	S	U	S	U	S	S	–	–	S	S	U	U	S	U
Sulfuric Acid ³ , ⁵ **	75-95	U	U	S	U	U	U	S	U	–	–	U	U	U	U	S	U
Sulfuric Acid ³ , ⁵ **	96-98	U	U	U	U	–	–	S	U	–	–	U	U	U	U	S	U
Sulfuric Acid, Fuming ³ / ⁵ **		U	U	U	U	U	U	U	U	–	–	U	U	U	U	S	–
Sulfurous Acid	Conc.	S	S	S	S	S	S	S	S	S	S	S	S	U	U	S	–
Tallow		S	U	S	U	S	U	S	S	–	–	–	–	–	–	S	S
Tannic Acid*	Conc.	U	U	S	S	S	S	S	S	S	S	S	S	–	S	S	S
Tanning Liquors*		–	–	S	S	–	–	S	U	–	–	S	S	–	–	–	S
Tartaric Acid	Satd.	S	S	S	S	S	S	S	S	S	S	S	S	–	S	S	–
Tetrachlorethane		U	U	U	U	U	U	S	S	–	–	–	–	U	U	S	S

See page 44 for chart and footnote legend.

Chemical Resistance

Description	% Conc.	LLDPE/LDPE/ HDPE		XLPE1		PP		PVDF		FRP		PVC		EPDM	NEOPRENE	VITON®	316
		70°F	140°F	70°F	140°F	70°F	140°F	70°F	140°F	70°F	140°F	70°F	140°F	70°F	70°F	70°F	70°F
Tetrahydrofuran*		U	U	U	U	U	U	U	U	-	-	U	U	U	U	U	S
Thionyl Chloride		U	U	U	U	U	U	U	U	-	-	U	U	-	-	-	U
Toluene*†		U	U	U	U	U	U	S	S	S	U	U	U	U	S	S	
Transformer Oil*		U	U	S	U	S	U	-	-	-	-	U	U	-	-	-	S
Trichloroethylene		U	U	U	U	U	U	S	U	S	S	U	U	U	U	S	S
Trisodium Phosphate		S	S	S	S	S	S	S	S	S	S	S	S	S	S	S	-
Turpentine*	Satd.	U	U	U	U	U	U	S	S	U	U	U	U	U	U	S	S
Urea*		U	U	S	S	S	S	S	S	S	S	S	U	-	-	-	S
Urine	Conc.	S	S	S	S	S	S	S	S	S	S	S	S	S	U	S	S
Vanilla Extract*		U	U	S	S	S	S	-	-	-	-	-	-	-	-	-	-
Vinegar* (4-8% of Acetic Acid)		U	U	S	S	S	S	S	S	S	S	S	S	S	S	S	S
Water, Acid, Mine		-	-	S	S	S	-	S	U	-	-	S	S	-	U	S	U
Water, Distilled		-	-	S	S	S	S	S	S	-	-	S	S	S	S	S	S
Water, Deionized		U	U	S	U	S	S	S	S	-	-	S	S	S	S	S	S
Water, Fresh		S	S	S	S	S	S	S	S	S	S	S	S	S	S	S	S
Water, Salt		S	S	S	S	S	S	S	S	S	S	S	S	S	S	S	U
Wetting Agents*		U	U	S	S	U	U	S	S	S	S	-	-	-	-	-	-
Whiskey*		U	U	S	S	S	S	S	S	-	-	S	S	S	S	S	S
White Liquor (Pulp Mill)		-	-	-	-	S	-	S	U	-	-	S	S	-	S	S	S
White Water (Paper Mill)		-	-	-	-	S	-	-	-	-	-	-	-	-	S	S	S
Wines		S	S	S	S	S	S	S	S	-	-	S	S	-	-	S	-
Xylene*†		U	U	U	U	U	U	S	S	U	U	U	U	U	U	S	S
Yeast		S	S	S	S	S	S	S	S	S	S	-	-	S	S	S	-
Zinc Salts		S	S	S	S	S	S	S	S	S	S	S	S	S	S	S	-

Legend

S – Satisfactory

U – Unsatisfactory

- – No Test Data

* – These chemicals can cause stress-cracking of LLDPE, LDPE and HDPE under certain conditions. Rotomolded tanks are essentially stress-free and are not usually affected by stress-cracking chemicals. However, these chemicals may affect the service life of tanks with welded fittings or seams, and unsupported tanks operating under heavy loads. Use XLPE tanks which have excellent environmental stress-crack resistance.

** – Limited Warranty one year—see page 45.

+ – Permeation by this solvent may cause softening, swelling and/or considerable loss of fluid in polyethylene tanks.

1 – XLPE exhibits high environmental stress-crack resistance, but available data is limited and tests are recommended for severe conditions or chemicals not listed in this chart.

2 – Mostly satisfactory, but black liquor varies considerably in composition and temperature. Field testing is recommended.

3 – Use of Sulfuric Acid may cause initial discoloration of interior tank wall surface due to oxidation.

- Refer to Chemical Resistance Chart for fittings and gaskets.

4 – Vapors from **Hydrochloric Acid** are extremely aggressive. When storing this product, please make sure you have installed an appropriate **scrubbing system** or specify a **bolted and gasketed manway cover** with plastic bolts. **Contact Saint-Gobain for pricing.**

5 – For Bulk Storage of **Sulfuric Acid concentrations between 80%-95%** please specify XLPE Tanks designed for **2.2 specific gravity**. We recommend this heavier wall tank due to the stress-cracking and oxidizing nature of this chemical. **Contact Saint-Gobain for pricing** on these tanks.

WARNING: Misuse of Saint-Gobain products can be potentially dangerous. Before using this product, please refer to the appropriate Saint-Gobain catalogs/inserts and the various warnings, information, instructions and chemical resistance chart. If any doubt exists about a specific use of Saint-Gobain products, please

contact Technical Support, Saint-Gobain Performance Plastics, 1044 MacArthur Rd., Reading, PA 19605 or call (800) 451-0770, fax (610) 376-4802.

Materials

LLDPE—Linear Low-Density Polyethylene

LDPE—Low-Density Polyethylene

HDPE—High-Density Polyethylene

XLPE—Cross-Linked High-Density Polyethylene

PP—Polypropylene

PVDF—Polyvinylidene Fluoride

FRP—Fiberglass-Reinforced Polyester

PVC—Polyvinyl Chloride

EPDM—Ethylene Propylene Diene Monomer

NEOPRENE—A chloroprene polymer, synthetic rubber

VITON® —A fluoroelastomer, registered trademark of E.I. du Pont de Nemours and Company, Inc.

Warranty and How to Order

How to Order Saint-Gobain Tanks and Accessories

Saint-Gobain Performance Plastics tanks and other products are available from authorized Saint-Gobain Performance Plastics Distributors throughout the U.S., Canada and Puerto Rico.

Always order by complete catalog number (first four or five digits) and size code (last four digits). Be sure to include a brief product description and drawing showing the location of installed fittings, where necessary. For example: one each 11100-0005 cylindrical tank and one each 93857-0050 nipple installed through side.

Drawings are required when fittings are to be factory installed.

- **Covers:** Covers are included with tanks, and are sold as part of a complete package—TANK/COVER COMBINATION.
- **Freight:** All shipments are F.O.B. Reading, Pennsylvania; Garrett, Indiana; or other distribution points.
- **Applications:** Saint-Gobain Performance Plastics records application details for all bulk tank orders. This information

ensures correct usage of bulk tanks and supports the Saint-Gobain warranty. Please submit the following with all bulk tank orders:

- Chemicals and concentration
- Service temperatures
- Specific gravity of contents

NOTE: Many Saint-Gobain Performance Plastics Distributors stock Saint-Gobain Performance Plastics tanks. Please check with the Saint-Gobain Performance Plastics Distributor in your area for potential freight savings.

For assistance, call your nearest Saint-Gobain Performance Plastics Distributor or Saint-Gobain at (800) 451-0770.

- **Delivery:** Standard tanks are generally available for prompt delivery from stock. If your order is unusual in quantity, size or fittings required, or if it involves a major installation, please contact Saint-Gobain Performance Plastics for delivery information.

- **Return Goods Procedure:** No material will be accepted for return without written authorization. Authorized returns must carry a Saint-Gobain Performance Plastics “Authorized Return” label on the outside of the carton. These labels are available from Saint-Gobain Performance Plastics. A certificate of safe handling is also required. **Specially fabricated or factory-modified tanks may not be returned for credit.**

NOTE: Plastic tanks which are subject to chemical, physical and/or thermal exposure should be inspected on a routine basis for any signs of leaking, cracking, discoloration, bulging or other deviations from the “as new” condition. The frequency of inspection will be highly dependent upon actual use conditions, as well as the age of the tank. Specific guidelines must be determined by the user dependent upon actual use conditions. Saint-Gobain cannot provide specific guidelines due to the wide variety of applications and their effects on plastic tanks. Please consult this catalog or contact Saint-Gobain for more information.

Manufacturing Facilities

Saint-Gobain Performance Plastics
2664 Gilchrist Road
Akron, Ohio 44305
Tel: (800) 798-1554, (330) 798-9240
Fax: (330) 798-6968
*TYGON® Brand Flexible Tubing,
Chemfluor® Tubing*
www.tygon.com
www.biopharm.saint-gobain.com
www.medical.saint-gobain.com

Saint-Gobain Performance Plastics
P.O. Box 481, 3910 Industrial Drive
Beaverton, Michigan 48612
Tel: (888) 387-0067, (989) 435-9533
Fax: (989) 453-2355
*TYGON® Brand Extruded Silicone
and Molded Components*
www.biopharm.saint-gobain.com
www.medical.saint-gobain.com
www.industrialsilicone.com

Saint-Gobain Performance Plastics
460 Milltown Road
Bridgewater, New Jersey 08807
Tel: (800) 435-3992, (908) 218-8888
Fax: (908) 218-9009
*Flexible Components, Sanitary
Couplers ReSeal® and PermaSeal®,
Sani-Tech® Products*
www.flexiblecomponents.com
www.reseal.com
www.tanks.saint-gobain.com

Saint-Gobain Performance Plastics
I-295 @ Harmony Road
Mickleton, New Jersey 08056
Tel: (800) 543-8823, (856) 423-6630
Fax: (856) 423-8182
*Roll Cover, Engineered
Extrusions, Tanks*
www.bunnell-plastics.com

Saint-Gobain Performance Plastics
150 Dey Road
Wayne, New Jersey 07470-4669
Tel: (973) 696-4700
Fax: (973) 696-4056
Chemware®
www.labpure.com

Saint-Gobain Performance Plastics
700 Warner Blvd.
Taunton, Massachusetts 02780
Tel: (508) 823-7701
Fax: (508) 823-1438
*Specialty Extruded and
Molded Silicone Products*
www.biopharm.saint-gobain.com
www.medical.saint-gobain.com

Saint-Gobain Performance Plastics
La Mothe-aux-Aulnaies
F-89120 Charny France
Tel: (33) 3-86-63-78-78
Fax: (33) 3-86-63-77-77
Silicone Products, Hose Assemblies
www.verneret.com

Saint-Gobain Performance Plastics
P.O. Box 1344, 11 Sichio Drive
Poestenkill, New York 12140
Tel: (518) 283-5963
Fax: (518) 283-1418
Specialty Closures
www.packagepure.com

Saint-Gobain Performance Plastics
2316 West Wisconsin Street
Portage, Wisconsin 53901
Tel: (800) 236-7600, (608) 742-8541
Fax: (608) 742-3179
Specialty Molded Silicone Components
www.medical.saint-gobain.com

Sales Offices

Saint-Gobain Performance Plastics
1468 Kun Yang Road
Minhang Economic & Technological
Development Zone,
Shanghai, China 200245
Tel: (86) 21-5472-1568
Fax: (86) 21-5472-2378/5472-2379

Saint-Gobain Performance Plastics
19801-5, Haramura, Suwa-gun
Nagano 391-0100,
Japan
Tel: (81) 266-79-6400
Fax: (81) 266-70-1001

Saint-Gobain Performance Plastics
13th Floor, Donghsin Building
141-28, Samsung-Dong
Kangnam-Ku Seoul, 135-090
Korea
Tel: (82) 2-501-7361
Fax: (82) 2-554-1550

Saint-Gobain Performance Plastics
Suite 1203
147 Chienkwo North Road
Section 2, Taipei, 104
Taiwan
Tel: (886) 2-2503-4201
Fax: (886) 2-2503-4202

Saint-Gobain Performance Plastics
50, Jalan PJS 11/20, Bandar Sunway,
46150 Petaling Jaya, Selangor DE,
Malaysia
Tel: (603) 56364082
Fax: (603) 56364099

Saint-Gobain Performance Plastics
3-7, Kojimachi, Chiyoda-ku
Tokyo 102-0083,
Japan
Tel: (81) 3-3263-0285
Fax: (81) 3-3263-0286

Saint-Gobain Performance Plastics
Grindwell Ltd
Via Old Madras Road
Bangalore 560 049,
India
Tel: (91) 80-847-2900
Fax: (91) 80-847-2905

Saint-Gobain Performance Plastics
148 Newton Road
Wetherill Park, NSW 2164
Australia
Tel: (61) 2-9749-3598
Fax: (61) 2-9643-2926

Saint-Gobain Performance Plastics
Av Independencia 7031
13280-000 Vinhedo-SP
Brazil
Tel: (55) 19-3876-8153
Fax: (55) 19-3876-8077

*TYGON, ReSeal, Chemfluor, Sani-Tech, Chemware and Norton are registered trademarks.
Viton is a trademark of E.I. du Pont de Nemours and Company.
LuerLok is a registered trademark of Becton Dickinson.*

Notice:

Due to our continuous efforts to improve our products, the information contained in this document is subject to change without notice. Saint-Gobain Performance Plastics assumes no obligations or liability for any advice furnished by it, or for results obtained with respect to those products. All such advice is given and accepted at the buyers' risk. Final determination of suitability of any information or product for the use to be contemplated is the sole responsibility of the user. This document contains proprietary information, which is protected by copyright, and may not be reproduced in any form without written consent of Saint-Gobain Performance Plastics.

NOTE: Saint-Gobain Performance Plastics Corporation does not assume any responsibility or liability for any advice furnished by it, or for the performance or results of any installation or use of the product(s) or of any final product into which the product(s) may be incorporated by the purchaser and/or user. The purchaser and/or user should perform its own tests to determine the suitability and fitness of the product(s) for the particular purpose desired in any given situation.



Saint-Gobain Performance Plastics
460 Milltown Road
Bridgewater, New Jersey 08807
Tel: (800) 435-3992, (908) 218-8888
Fax: (908) 218-9009

www.tanks.saint-gobain.com